



भारत का राजपत्र The Gazette of India

सी.जी.-डी.एल.-अ.-10012023-241834
CG-DL-E-10012023-241834

असाधारण
EXTRAORDINARY

भाग I—खण्ड 1
PART I—Section 1

प्राधिकार से प्रकाशित
PUBLISHED BY AUTHORITY

सं. 10]

नई दिल्ली, मंगलवार, जनवरी 10, 2023/पौष 20, 1944

No. 10]

NEW DELHI, TUESDAY, JANUARY 10, 2023/PAUSHA 20, 1944

नागर विमानन मंत्रालय

अधिसूचना

नई दिल्ली, 9 जनवरी, 2023

फा. सं. एवी-24032/56/2021-एएआई-एमओसीए.—जबकि दिव्यांगजन अधिकार अधिनियम, 2016 की धारा 40 में परिकल्पना की गई है कि केंद्र सरकार, मुख्य आयुक्त के परामर्श से, शहरी एवं ग्रामीण क्षेत्रों में आम जनता को उचित प्रौद्योगिकी तथा प्रणालियाँ, एवं अन्य सुविधाएं और सेवाएँ प्रदान करने के साथ-साथ प्राकृतिक वातावरण, परिवहन, सूचना तथा संचार के लिए पहुँच के मानक निर्धारित करने के क्रम में दिव्यांगजनों के लिए नियम तैयार करेगी।

और जबकि, नागर विमानन मंत्रालय, नागर विमानन क्षेत्र से संबंधित मुद्दों के लिए नोडल केन्द्रीय मंत्रालय है, तथा तदनुसार, मंत्रालय ने हितधारकों एवं मुख्य आयुक्त, दिव्यांगजन के कार्यालय के परामर्श से, दिव्यांगजनों एवं अन्य प्रयोक्ता समूहों की पहुँच की आवश्यकताओं, जो उन्हें समुचित वातावरण उपलब्ध कराने एवं हवाई यात्रा से जुड़ी सेवाओं के संदर्भ में हो, का समाधान करने के उद्देश्य से 'नागर विमानन के लिए पहुँच मानक एवं दिशानिर्देश' तैयार किए हैं।

अब, नागर विमानन मंत्रालय एतद्वारा 'नागर विमानन के लिए पहुँच मानक तथा दिशानिर्देश' अधिसूचित करता है तथा यह <https://www.civilaviation.gov.in>; <https://www.aai.aero>; <https://www.dgca.gov.in> एवं <https://www.bcasindia.gov.in> पर उपलब्ध है।

रुबीना अली, संयुक्त सचिव

MINISTRY OF CIVIL AVIATION**NOTIFICATION**

New Delhi, the 9th January, 2023

F. No. AV-24032/56/2021-AAI-MoCA.—Whereas Section 40 of the Rights of Persons with Disabilities Act, 2016 envisages that the Central Government shall, in consultation with the Chief Commissioner, formulate rules for persons with disabilities laying down the standards of accessibility for the physical environment, transportation, information and communications, including appropriate technologies and systems, and other facilities and services provided to the public in urban and rural areas.

And whereas, Ministry of Civil Aviation is the nodal Central Ministry with respect to issues concerning civil aviation sector and accordingly, developed ‘Accessibility Standards and Guidelines for Civil Aviation’ with intend to address the accessibility needs of persons with disabilities and other user groups in context of built environment and services associated with air travel, in consultation with stakeholders and office of the Chief Commissioner for Persons with Disabilities;

Now, Ministry of Civil Aviation hereby notifies the ‘Accessibility Standards and Guidelines for Civil Aviation’ and the same is available at <https://www.civilaviation.gov.in>; <https://www.aai.aero>; <https://www.dgca.gov.in> and <https://www.bcasindia.gov.in>.

RUBINA ALI, Jt. Secy.

Copyright © 2022, Ministry of Civil Aviation, Airports Authority of India

Published in April 2022

Project Team

Charul Shukla, AAI

Archana Sakharwade, AAI

Published by

Ministry of Civil Aviation

New Delhi

Government of India

Disclaimer

This book is intended as a guidebook for creating best practices and acceptable standards for universal accessibility in airports. Ministry of Civil Aviation or the team shall not be responsible for any loss, damage or injury that may be suffered by any person in connection with the usage of the facilities designed on the basis of the recommendations in this book.

All rights reserved. No part of this publication may be reproduced, revised, stored in a retrieval system or transmitted in any form or by any means, electronic, mechanical photocopying, recording or otherwise, without due acknowledgements or prior written permission of the Ministry of Civil Aviation.

ACCESSIBILITY STANDARDS AND GUIDELINES FOR CIVIL AVIATION

2022

**MINISTRY OF CIVIL AVIATION
GOVERNMENT OF INDIA**



Preface

Ministry of Civil Aviation published the 'Accessibility Standards and Guidelines for Civil Aviation' to assist people comprehend and understand the Universal Accessibility Standards. It would help people providing the services at airports in understanding the needs of persons with reduced mobility, old people, children, expecting mothers, and various other users to make air travel convenient for everyone by incorporating the accessibility features. Only by incorporating the requirements of various user groups can we make a truly universal design and ensure that everyone has a hassle-free travel experience.

Through a series of four parts, each of which is separated into chapters, these guidelines establish a framework for educating and guiding various airport operators, airlines, security agencies and other professionals involved for the design, planning, and implementation of accessibility in built environment.

It provides a comprehensive approach in understanding the accessibility in an Indian context, by transitioning from barrier-free approach to a universal design philosophy. The guidelines should be read in conjunction with the existing standards of Civil Aviation and built environment.

This document is a foundation stone in achieving accessible airports. Its true success shall be seen in the implementation at various airports resulting in more safe, inclusive and convenient customer experience and we believe that it will happen over time.



Acknowledgement

In order to fulfill the national and international goal of creating fully accessible built environment Ministry of Civil Aviation (MOCA), Government of India took upon the task to make 'Accessibility Standards and Guidelines for Civil Aviation, 2022'. These guidelines intend to address the accessibility needs of persons with disabilities, elderly, women, children and other user groups with special needs, in context of built environments and services associated with air travel, thus paving the way for universally accessible and inclusive air travel.

These guidelines are a result of multiple consultations with various Central Government Ministries, airlines, domain experts, stakeholders and incorporates suggestions from various users, consultants and organizations working with persons with diverse user group.

The task of formulation of these guidelines was carried under the overall leadership of Ms. Rubina Ali, Joint Secretary (MOCA) and Shri. Narendera Singh, Under Secretary (MOCA), with support from Shri. Joyanta Chakraborty, Director (MOCA), Shri Indrakanti Narasimha Murthy, Member (Operations) and Shri. Anil Pathak, Member (Planning). Shri. Debashis Khan, ED (Architecture), Shri. Vivek Chaurey, ED (Operations) and Late. Arun Mehan gave guidance on making the guidelines more practical for implementation on site.

Ms. Charul Shukla, GM (Architecture) who is the Nodal officer of Accessible India Campaign in Airports Authority of India (AAI), supervised the formulation of the guidelines and coordinated consultations with all the Ministries and stakeholders. Ms. Archana Sakharwade, AM (Architecture) conceptualized, drafted, illustrated and revised these guidelines. Other architects working in Planning Department also gave their suggestions. The Ministry acknowledges the comprehensive work done by the team from AAI for the complete process of developing the draft guidelines, reviewing it multiple times and incorporating the inputs from various stakeholders.

Gratitude is also expressed towards Shri. Srinivasan Ramakrishnan, KAI center who guided the team on various aspects of Accessibility in ICT, Ms. Tarika Roy, Joint Secretary who was earlier coordinating Accessible India Campaign discussions with all the Central Ministries, Shri. Himanshu Das (Director, National Institute for the Empowerment of Persons with Visual Disabilities) for his guidance on accessibility for people with visual Disabilities, Shri. Subhash Vashishth, CABE Foundation, Shri. Shubham Rathore, Ministry of Social Justice and Empowerment (MOSJE) for giving time-to-time advice.

The guidelines wouldn't have been revised without the valuable inputs and suggestions provided by so many other participants and contributors including the reviews carried out by Bureau of Civil Aviation Security (BCAS), airlines, the Chief Commissioner of Persons with Disabilities, MOSJE and the responses received in the Public Opinion round.

It is impossible to acknowledge every person who directly or indirectly has helped in the formulation of these guidelines but the authors duly acknowledge the support rendered by countless anonymous individuals whose individual case studies, experiential insights and interactions with whom added value to the preparation of this document. We sincerely thank them for their valuable contributions and express our sincere gratitude to all those who would be implementing it at various airports.



AIRPORT OPERATOR

WE ALL
WORK
TOGETHER
TO ENSURE
ACCESSIBLE
AIR TRAVEL



AIRLINES



SECURITY AGENCIES

Contents

Preface	ii
Acknowledgement	iv
Contents	vi
List of Figures	viii
List of Images	ix
List of tables	x
Introduction	1
1. Ministry of Civil Aviation	1
2. Airports Authority of India	1
3. About the book.....	1
4. International and National Policy Perspectives	2
5. Background.....	4
6. Definitions	5
7. Scope and applicability.....	6
8. Basic Anthropometry and Space Allowances	6
Part A: Accessibility Features to be provided by Airport Operator	11
1. Accessible Parking and drop-off/pick up point.....	11
2. Accessible Route/Approach	17
3. Accessible Entrance to the Building	18
4. Accessible Reception (Helpdesk).....	19
5. Check-in area.....	22
6. Security Check.....	23
7. Accessible Corridor (Main passenger movement zone).....	24
8. Baggage Claim	26
9. Seating Spaces	27
10. Immigration and Custom	28
11. Tactile Ground Surface Indicators (TGSI).....	28
12. Accessible lift	30
13. Ramps	32
14. Steps and Staircase	37
15. Handrails.....	40
16. Accessible Toilets	42
17. Accessible Drinking Water Facility.....	49
18. Service Animal/Pet Relief Area (SARA)	51
19. Signage.....	54
20. Aerobridge and Ambulift.....	65

21. Low Floor Buses	66
Part B: Accessibility features to be provided by Airlines	69
1. Facilities provided on the website.....	69
2. Call Centre/Airline/ OTA ticketing	70
3. Services at the Airport.....	70
4. Mobility Aid.....	70
5. Travelling with a trained service dog	71
6. Special assistance	71
7. Boarding/Ramp/Coach.....	71
8. Onboard.....	73
9. Forms.....	74
10. Training.....	74
11. Standardized Training and Audits	75
Part C: Accessibility features to be provided by Security Agencies.....	77
1. Introduction	77
2. General Principles:.....	77
3. Screening of passengers with mobility disability, aids and devices:.....	79
4. Screening of passenger with prosthetics:	80
5. Screening of passengers who cannot remove shoes, medical device or bandages.....	81
6. Screening of visual/ hearing and speech impaired passengers:	82
7. Screening of passengers with service animals (Guide Dog):.....	84
8. Screening of passengers having Alzheimer's, Dementia, Aphasia, Autism or Hidden Disabilities:.....	85
9. Screening of Ambulance passenger:.....	85
10. Screening of medication and associated supplies:	85
11. X-ray screening of respiratory equipment:	86
Part D: Guidelines for Evacuation Protocol	88
1. General	88
2. Visual Impairments.....	88
3. Hearing Impairments.....	88
4. Mobility Impairments/Wheelchair users	89
5. Ambulatory Mobility Impairments	89
6. Speech Disabilities.....	89
7. Service Animals:	90
References	91
Annexure A.....	93
1. Support for Persons with Intellectual Disabilities (PwIDs).....	93
Annexure B.....	94

List of Figures

Figure 1: Anthropometric and Spatial Allowances	7
Figure 2: Reach Diagrams	8
Figure 3: Dimensions of a wheelchair	8
Figure 4: Schematic diagram showing the preferred location of reserved parking for persons with disability near terminal building	11
Figure 5: Reserved parking near terminal building for persons with disability.....	12
Figure 6: On-floor marking of reserved parking near terminal building for persons with disability	13
Figure 7: Vertical sign at City side kerb for accessible drop-off point.....	14
Figure 8: Example of guiding path from accessible drop-off/pick-up point on the city side kerb to the entry gate.....	15
Figure 9: International Symbol of Accessibility	16
Figure 10: Details of on-floor International Symbol of Accessibility	16
Figure 11: Example of tactile ground surface indicators used in open area	17
Figure 12: Example of an accessible approach with ramp and stairs connecting the drop off zone to entry gate	18
Figure 13: Typical Helpdesk design for ease of wheelchair users	19
Figure 14: Example of warning tiles in front of check-in counters in small airports	22
Figure 15: Example of accessible route connecting each check-in counter island in big airports	22
Figure 16: Preferred width of corridor.....	24
Figure 17: Minimum Clear width requirement of accessible corridors.....	25
Figure 18: Space requirement for right angled turn in an accessible corridor	25
Figure 19: Location of Universal Symbol of Accessibility marking on ground	26
Figure 20: Details of on-floor International Symbol of Accessibility for Baggage Claim Area	26
Figure 21: Reserved seating with tactile flooring in front	27
Figure 22: Example of reserved seats for PRM near each boarding gate	27
Figure 23: Tactile ground surface indicators (TGSi).....	29
Figure 24: Arrangement of Tactile blocks for people with visual impairment	29
Figure 25: Placement of tactile tiles at a door	29
Figure 26: Lift details shown in plan and section	31
Figure 27: Handrails and tactile flooring for ramp with railing	33
Figure 28: Examples of different types of ramps with railings.....	34
Figure 29: Types of kerb ramps shown in plan.....	35
Figure 30: Types of kerb ramp shown in view	36
Figure 31: Handrails for steps and stairs	37
Figure 32: Staircase detail	38
Figure 33: Handrails at two levels to help children, old people and people with short stature..	40
Figure 34: Typical handrail extensions.....	40
Figure 35: Example of Type A Toilet Room - Lateral Transfer from both sides	43
Figure 36: Example of Type B corner toilet - Lateral transfer from one side only	43
Figure 37: Positioning accessories in Type B toilet	44
Figure 38: Placement of washbasin and mirror with distances of sanitary appliances.....	45
Figure 39: Section showing washbasin with toe and knee clearance	45
Figure 40: Typical toilet block plan.....	47
Figure 41: Section showing grab bar placement in Indian toilet cubical.....	48

Figure 42: Clear floor space for freestanding or built-in drinking water unit not having clear space under the unit.....	49
Figure 43: Wall-mounted drinking water unit details.....	49
Figure 44: Details of Service Animal/Pet Relief Area	52
Figure 45: Languages to be used for signage	54
Figure 46: Details of signage for accessible parking	55
Figure 47: Details of signage for Pick-up point at arrival	56
Figure 48: Details of signage for drop-off point at departure	57
Figure 49: Details of Helpdesk call booth (to be given on city-side kerb) and its signage.....	58
Figure 50: Details of signage near ramp along the kerb.....	59
Figure 51: Details of signage for Airport Help.....	60
Figure 52: Details of signage for Priority Counter.....	61
Figure 53: Details of signage for unisex accessible toilet	62
Figure 54: Details of signage for accessible lift	63
Figure 55: Details of signage for Service Animal/Pet Relief Area	64

List of Images

Image 1: Example of parking symbol on floor, transfer bay marking and kerb ramp.....	14
Image 2: Large Tactile Floor Plan at one of the entrances to the terminal building at Ciampino Airport in Rome, Italy	20
Image 3: Example of tactile map of building to be displayed near the reception desk	20
Image 4: Example of Braille sign map and tactile facility at Mysuru Railway Station	21
Image 5: Accessible India Campaign badges to be worn by volunteers at the airport	21
Image 6: Priority Check-in for people with reduced mobility	23
Image 7: Example of required toe space below the priority check in counter and signage example	23
Image 8: Example of lift buttons and railing.....	30
Image 9: Example of tactile flooring provided at the beginning of the staircase.....	39
Image 10: Example of tactile flooring provided at the beginning of the staircase and handrails at two levels.....	39
Image 11: Braille indicators at end of the handrails.....	41
Image 12: Tactile indicators at end of the handrails in three languages including Braille	41
Image 13: Example of lever type tap, foldable grab bars, etc. in accessible toilet type A	46
Image 14: Example of type B toilet with emergency alarm pull chord at two levels	46
Image 15: Examples of accessible urinal and low height urinal for children	48
Image 16: Example of Drinking water facility with taps on two levels installed in Madurai Airport	50
Image 17: SARA at Hartfield Jackson Atlanta Airport.....	52
Image 18: SARA at St. Louis Lambert International Airport.....	53
Image 19: SARA at Edmonton International Airport	53
Image 20: Example of colours for Signage.....	54
Image 21: Example of aerobridge at Chennai Airport.....	65
Image 22: Example of Ambulift	65
Image 23: Example of a bus with ramp at Lucknow Airport.....	66
Image 24: Wheelchair assistance option on Indigo Airlines Website	69
Image 25: Special assistance option on Indigo Airlines Website	69
Image 26: Wheelchair service provided at Airports	70
Image 27: Low floor buses and buses with in-built ramp	72

Image 28: Ramp provided by Airlines	72
Image 29: Example of Aisle chair to be used on-board	73
Image 30: Medical form available on Airlines website	74
Image 31: Training to be given to Airline staff	74

List of tables

Table 1: Number of reserved car parking spaces in parking lot.....	11
Table 2: Design elements to be used for difference in floor levels.....	18
Table 3: Gradient and length of ramps.....	32
Table 4: Changes in levels.....	33

Note: This document uses IEEE style of referencing where the numbers at the end of a sentence give the reference number of the document used. The document details can be viewed by correlating the number with the reference list attached in the end of the document.

Introduction



Introduction

1. Ministry of Civil Aviation

The Ministry of Civil Aviation (MOCA) is responsible for formulation of national policies and programs for the development and regulation of the Civil Aviation sector in the country. It is responsible for the administration of the Aircraft Act, 1934, Aircraft Rules, 1937 and various other legislations pertaining to the aviation sector in the country. This Ministry exercises administrative control over attached and autonomous organizations like the Directorate General of Civil Aviation, Bureau of Civil Aviation Security and Indira Gandhi Rashtriya Udan Academy and affiliated Public Sector Undertakings like National Aviation Company of India Limited, Airports Authority of India and Pawan Hans Helicopters Limited.

2. Airports Authority of India

The Airports Authority of India (AAI) is a statutory body working under the Ministry of Civil Aviation responsible for creating, upgrading, maintaining and managing Civil Aviation infrastructure and managing Indian air space including adjoining oceanic areas. It was formed on 1st April, 1995 by merging the International Airports Authority of India and the National Airports Authority with a view to accelerate the integrated development, expansion, and modernization of the operational, terminal and cargo facilities at the airports in the country conforming to international standards. It endeavors to enhance focus on customer satisfaction and undertake improvements for upgradation of infrastructure and facilities.

AAI owns 136 airports, which include 24 International Airports (including 3 International Civil Enclaves), 10 Customs Airports (including 4 Customs Civil Enclaves), 80 Domestic Airports and 22 Domestic Civil Enclaves at Defense airfields.

The Mission of AAI is “To be the foundation of an enduring Indian Aviation network, providing high quality, safe and customer-oriented airport and air navigation services, thereby acting as a catalyst for economic growth in the areas we serve.”

3. About the book

As persons with disabilities and reduced mobility, like everyone else, are increasingly given the opportunity to travel by air, there is a need to standardize the conditions for travel of such persons so as to facilitate their acceptance and handling of their carriage by the airlines, airport operators, ground handling agencies, etc.

This document is an attempt at addressing the special requirements of airports and seeks to provide clear and concise standards and guidelines that can help develop new accessible airports as well as upgrade the infrastructure at the existing airports. This document is to be read in addition to the points covered in DGCA, Civil Aviation Requirements, Section-3 Air transport, Series ‘M’ Part I, revised on 09th July 2021.

This document states standards and guidelines on Accessible Airport Infrastructure, accessibility features to be provided by the Airlines and the Security Forces. It would help in implementing Universal Design features to enable passengers with disabilities and with reduced mobility to move about safely, freely and use all facilities within the airport terminals. It would also facilitate independent functioning of individuals, so that they can get into and participate in all activities of travel with dignity and safety.

4. International and National Policy Perspectives

4.1 UN Convention on the Rights of Persons with Disabilities, 2007 [1]

The Convention on the Rights of Persons with Disabilities, like the other United Nations human rights conventions, resulted from decades of activity during which group rights standards developed from aspirations to binding treaties. The Convention became one of the most quickly supported human rights instruments in history, with strong support from all regional groups. 160 States signed the Convention upon its opening in 2007 and 126 States ratified the Convention within its first five years.

The Convention follows the civil law tradition, with a preamble, in which the principle that "all human rights are universal, indivisible, interdependent and interrelated" of the Vienna Declaration and Programme of Action is cited. The 25-subsection preamble explicitly mentions sustainable development, notes that "disability" is an "evolving concept" involving interaction between impairments and environmental factors and mentions the importance of a "gender perspective". The purpose of the Convention is to promote, protect and ensure the full and equal enjoyment of all human rights and fundamental freedoms by all persons with disabilities, and to promote respect for their inherent dignity. There are eight guiding principles that underlie the Convention, delineated in Article 3:

1. Respect for inherent dignity, individual autonomy including the freedom to make one's own choices, and independence of persons
2. Non-discrimination
3. Full and effective participation and inclusion in society
4. Respect for difference and acceptance of persons with disabilities as part of human diversity and humanity
5. Equality of opportunity
6. Accessibility
7. Equality between men and women
8. Respect for the evolving capacities of children with disabilities and respect for the right of children with disabilities to preserve their identities

A lot of development has been done after 2006 by the United Nations and its members.

4.2 The Rights of Persons with Disabilities (RPwD) Act, 2016 [2]

The RPwD Act, 2016 was enacted on 28.12.2016 which came into force from 19.04.2017. The salient features of the Act are:

- I. Responsibility has been cast upon the appropriate governments to take effective measures to ensure that the persons with disabilities enjoy their rights equally with others.
- II. Disability has been defined based on an evolving and dynamic concept.
- III. The Act covers the following specified disabilities:
 1. Physical Disability
 - a. Locomotor Disability
 - i. Leprosy Cured Person
 - ii. Cerebral Palsy
 - iii. Dwarfism
 - iv. Muscular Dystrophy
 - v. Acid Attack Victims

- b. Visual Impairment
 - i. Blindness
 - ii. Low Vision
 - c. Hearing Impairment
 - i. Deaf
 - iii. Hard of Hearing
 - d. Speech and Language Disability
 - 2. Intellectual Disability
 - a. Specific Learning Disabilities
 - b. Autism Spectrum Disorder
 - 3. Mental Behaviour (Mental Illness)
 - 4. Disability caused due to-
 - a. Chronic Neurological Conditions such as-
 - i. Multiple Sclerosis
 - ii. Parkinson's Disease
 - b. Blood Disorder-
 - i. Haemophilia
 - iii. Thalassemia
 - iv. Sickle Cell Disease
 - 5. Multiple Disabilities
- IV. Additional benefits have been provided for persons with benchmark disabilities and those with high support needs.
- V. Every child with benchmark disability between the age group of 6 and 18 years shall have the right to free education.
- VI. 5% reservation in seats in Government and Government aided higher educational institutions for persons with benchmark disabilities.
- VII. Stress has been given to ensure accessibility in public buildings (both Government and private) in a prescribed time-frame.
- VIII. 4% reservation in Government jobs for certain persons or class of persons with benchmark disability.
- IX. The Act provides for grant of guardianship by District Court or any authority designated by the State Government under which there will be joint decision – making between the guardian and the persons with disabilities.
- X. Broad based Central & State Advisory Boards on Disability to be set up as policy making bodies.
- XI. The Act provides for strengthening of the Office of Chief Commissioner of Persons with Disabilities and State Commissioners of Disabilities which will act as regulatory bodies and Grievance Redressal agencies and also monitor implementation of the Act. These Offices will be assisted by an Advisory Committee comprising of experts in various disabilities.
- XII. Creation of National and State Fund to provide financial support to the persons with disabilities.
- XIII. The Act provides for penalties for offences committed against persons with disabilities.
- XIV. Designated special Courts to handle cases concerning violation of rights of PwDs.

4.3 Accessible India Campaign (AIC)

Accessibility is about giving equal access to everyone. As our social responsibility, people with reduced mobility should be given access to all facilities and services found in the communities.

With this intention in mind, Department of Empowerment of Persons with Disabilities (DEPwD) launched Accessible India Campaign (Sugamya Bharat Abhiyan) on 3rd December, 2015 as a nation-wide campaign for achieving universal accessibility for Persons with Disabilities (PwDs).

The campaign is based on the principles of the Social Model of Disability, that disability is caused by the way society is organized, and not the person's limitations and impairments. A barrier-free environment facilitates equal participation in all the activities and promotes an independent and dignified way of life.

This campaign has the vision to build an inclusive society in which equal opportunities are provided for the growth and development of Persons with Disabilities (PwDs) so that they can lead productive, safe and dignified lives. Accessible India Campaign seeks cooperation of all Central Government Departments/Ministries and State Governments to manifest this vision. It has two important components: the built environment accessibility and the transportation system accessibility.

5. Background

The Rights of Persons with Disabilities Act, 2016 states that the persons with disabilities enjoys the right to equality, life with dignity and respect for his or her integrity equally with others and steps shall be taken to utilize the capacity of persons with disabilities by providing appropriate environment and reasonable accommodation. Furthermore, no person shall be deprived of his or her personal liberty only on the ground of disability and the persons with disabilities shall have equal protection and safety in situations of risk, armed conflict, humanitarian emergencies and natural disasters.

More-over, the need to take special measures to ensure that the persons with disabilities enjoy the full range of human rights and fundamental freedom is recognized by Article 14 of the Indian Constitution. Hence, accessibility for all is recognized as a basic necessity, and there are attempts all over the world to ensure this. Universal design concept is now becoming fundamental to all designs especially built-environment widely used by the public, like the airports. Hence there was a need create a document that would help in making all airports in India more accessible for the users and standardize the accessibility and that is how the journey of making Accessibility Standards and Guidelines for Civil Aviation (ASGCA) started.

There are two major documents detailing the norms for the accessibility of built environments in India which formed the foundation blocks of this document. They are:

1. Annexure B, Anthropometrics and Specific Requirements for Barrier Free Buildings and Built Environment, Part 3 Development Control Rules and General Building Requirements, National Building Code of India, Bureau of Indian Standard (BIS), 2016 (referred to as NBC in this document).
2. Harmonised Guidelines & Standards for Universal Accessibility in India, Ministry of Urban Development, 2021 (referred to as HG in this document).

Apart from these documents, the following documents are important for the Civil Aviation sector:

1. ICAO Annex 9, 14th Edition, October 2015
2. DGCA, Civil Aviation Requirements, Section-3 Air transport, Series 'M' Part I, revised on 09th July, 2021 (referred to as CAR in this document)
3. Report of the Asok Kumar Committee for the Review of the Civil Aviation Requirements (CAR) for Persons with Disabilities, Ministry of Civil Aviation, 2012 – It is the report of a committee formulated on 22nd March 2012 to look into various issues relating to

improving the air travel by persons with disabilities and reduced mobility. It had representatives from all stakeholders like MOCA, AAI, Private Airport Operators, Airlines, Organizations working for Persons with reduced mobility/ disabilities, Bureau of Civil Aviation Security (BCAS) and Directorate General of Civil Aviation (DGCA). There were many meetings and online discussions with domain experts who gave their inputs in making the final committee report. Apart from reviewing CAR, they also gave suggestions for improvement of design of websites, accessories and facilities/ infrastructure etc. specially meant to facilitate comfortable air travel for the persons of reduced mobility and disability.

4. Bureau of Civil Aviation Security, AVSEC Circular No. – 01-2022, Standard Operating Procedure for screening of persons with special needs – Individual with disabilities and/or Individual with reduced mobility, February 2022

All the above mentioned documents were studied before making ASGCA and reference from the same has been taken as per the requirements of the airports. Apart from these, best international practices have been referred and suggestions given by the Ministry of Social Justice and Empowerment (MOSJE) in various meetings with MOCA and AAI representatives have been incorporated in this document. Furthermore, the draft of this document was put up for public opinion and a lot of suggestions were received from various domain experts, individuals, organizations representing persons with reduced mobility, etc. A lot of them have been incorporated in this final version.

6. Definitions

- 6.1 **“Person with benchmark disability”** means a person with not less than forty per cent of a specified disability where, specified disability has not been defined in measurable terms and includes a person with disability where specified disability has been defined in measurable terms, as certified by the certifying authority [3]
- 6.2 **“Person with disability”** means a person with long term physical, mental, intellectual or sensory impairment which, in interaction with barriers, hinders his full and effective participation in society equally with others [3]
- 6.3 **Person with reduced mobility (PRM)** means any person whose mobility when using transport is reduced due to any physical disability (sensory or locomotor; permanent or temporary), intellectual disability or impairment, or any other cause of disability, or age, and whose situation needs appropriate attention and the adaptation to his or her particular needs of the service made available to all passengers. [4]
- 6.4 **Service Animal** means dogs that are individually trained to do work or perform tasks for people with disabilities.
- 6.5 **Universal design** means the design of products, environments, programmes and services to be usable by all people to the greatest extent possible, without the need for adaptation or specialised design and shall apply to assistive devices including advanced technologies for particular group of persons with disabilities. [3]
- 6.6 **WCHR** - (Wheelchair — R for Ramp) passenger can ascend/descend steps and make own way to/from cabin seat but requires wheelchair for distance to/from aircraft, i.e. across ramp, finger dock or to mobile lounge as applicable. When service animal is accompanying passenger, specify the type of animal in free text of SSR Item. [5]
- 6.7 **WCHS** - (Wheelchair — S for Steps) — passenger cannot ascend/descend steps, but is

able to make own way to/ from cabin seat; requires wheelchair for distance to/from aircraft or mobile lounge and must be carried up/down steps. When service animal is accompanying passenger, specify the type of animal in free text of SSR Item. [5]

- 6.8 **WCHC** - (Wheelchair — C for Cabin Seat) — passenger completely immobile; requires wheelchair to/from aircraft/ mobile lounge and must be carried up/down steps and to/ from cabin seat. When service animal is accompanying passenger, specify the type of animal in free text of SSR Item. [5]

7. Scope and applicability

The provisions contained in this document are on airport infrastructure required for creating accessible airports, accessibility features to be provided by the Airlines and the Security Forces. These shall be applicable to all the airports in India including all the private airports and airports managed by AAI. Existing airports need to retrofit their infrastructure as much as possible to follow the design standards specified in this book. Furthermore, all the upcoming new airports need to incorporate the specified design features right from the planning stage.

The provisions contained in this book shall be applicable to the following:

- All Indian airlines/ carriers engaged in schedule and non-scheduled air transport services both domestic and international;
- All foreign airlines/ carriers engaged in schedule air transport operating to and from Indian Territory.
- All airport operators, including private/JVs, within Indian Territory.
- Aviation Security Group (ASG) / CISF / APSU deployed at airports

8. Basic Anthropometry and Space Allowances

Anthropometric dimensions help us understand the body and spatial requirements of diverse individuals. They can have different age, gender, abilities and socio-cultural distinctions of performing activities. To design the airports according to the needs of persons with disabilities and other diversities in an inclusive manner, it is fundamental to understand their specific anthropometric requirements. So, for any built environment to be inclusive and accessible, it is ideal to incorporate the widest range of anthropometric possibilities and then tactically design the elements to cater to the context.

Some of the typical anthropometric and spatial allowance dimensions as illustrated in the *Harmonised Guidelines & Standards for Universal Accessibility in India, 2021* are shown in Figure 1, Figure 2 and Figure 3 which elaborate the dimensions or spatial requirements for a person with walking stick, person with child in arms, wheelchair users, etc. They also elaborate the reach ranges for a person using wheelchair space and the clear passage widths in diverse built environment contexts.

Typically, spaces for wheelchairs or baby pram maneuvering along with radial ranges of white canes for persons with visual impairments need to be considered with care when creating inclusive facilities in various built environments. Good ergonomic designs and responsive space standards facilitate human independence and efficiency in built environments while catering to wide ranging adaptive needs of people. So, it is strongly recommended to consider these anthropometric requirements for diverse disabilities in context of their assistive technologies and create room for clearances in space design.

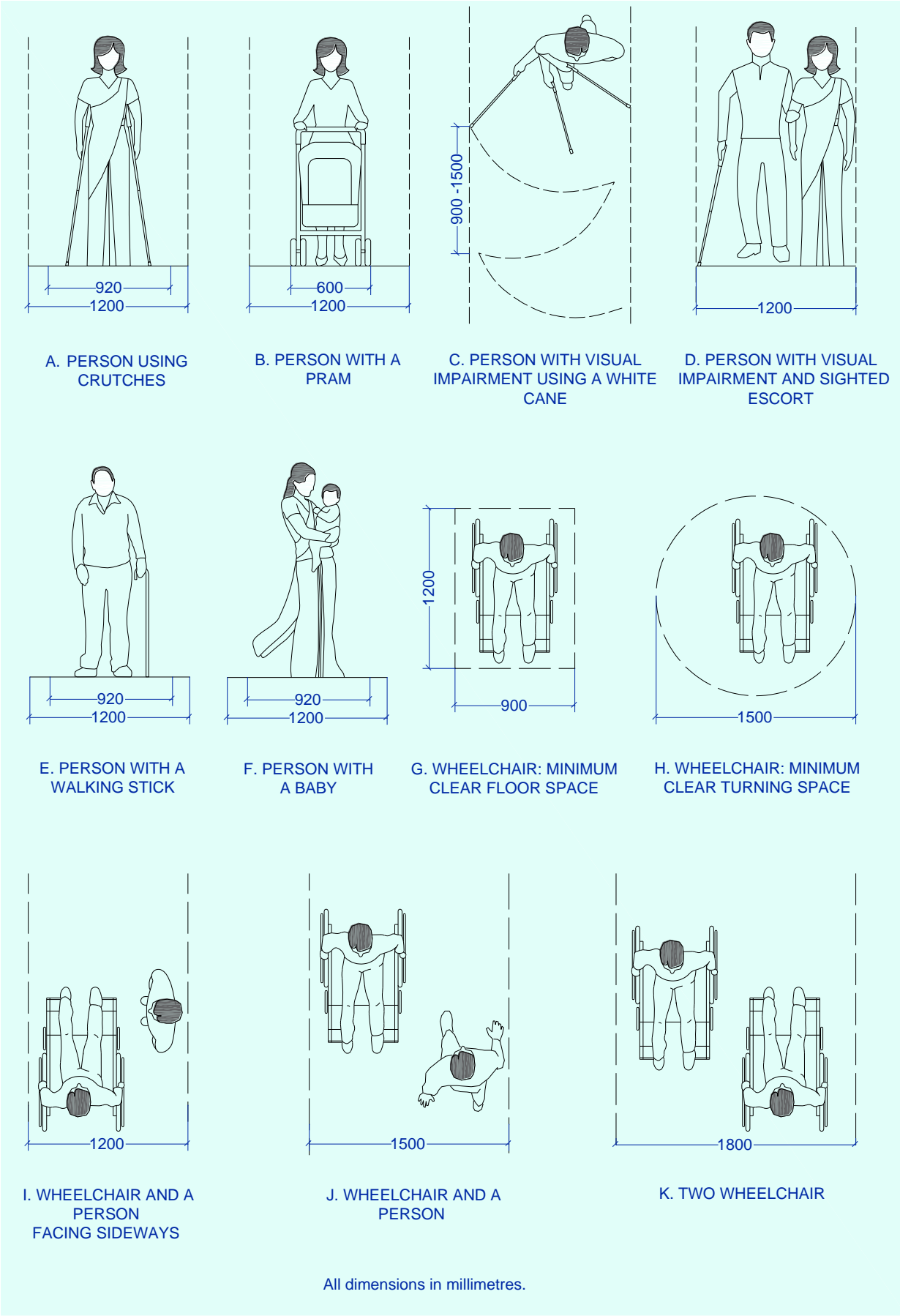

Figure 1: Anthropometric and Spatial Allowances

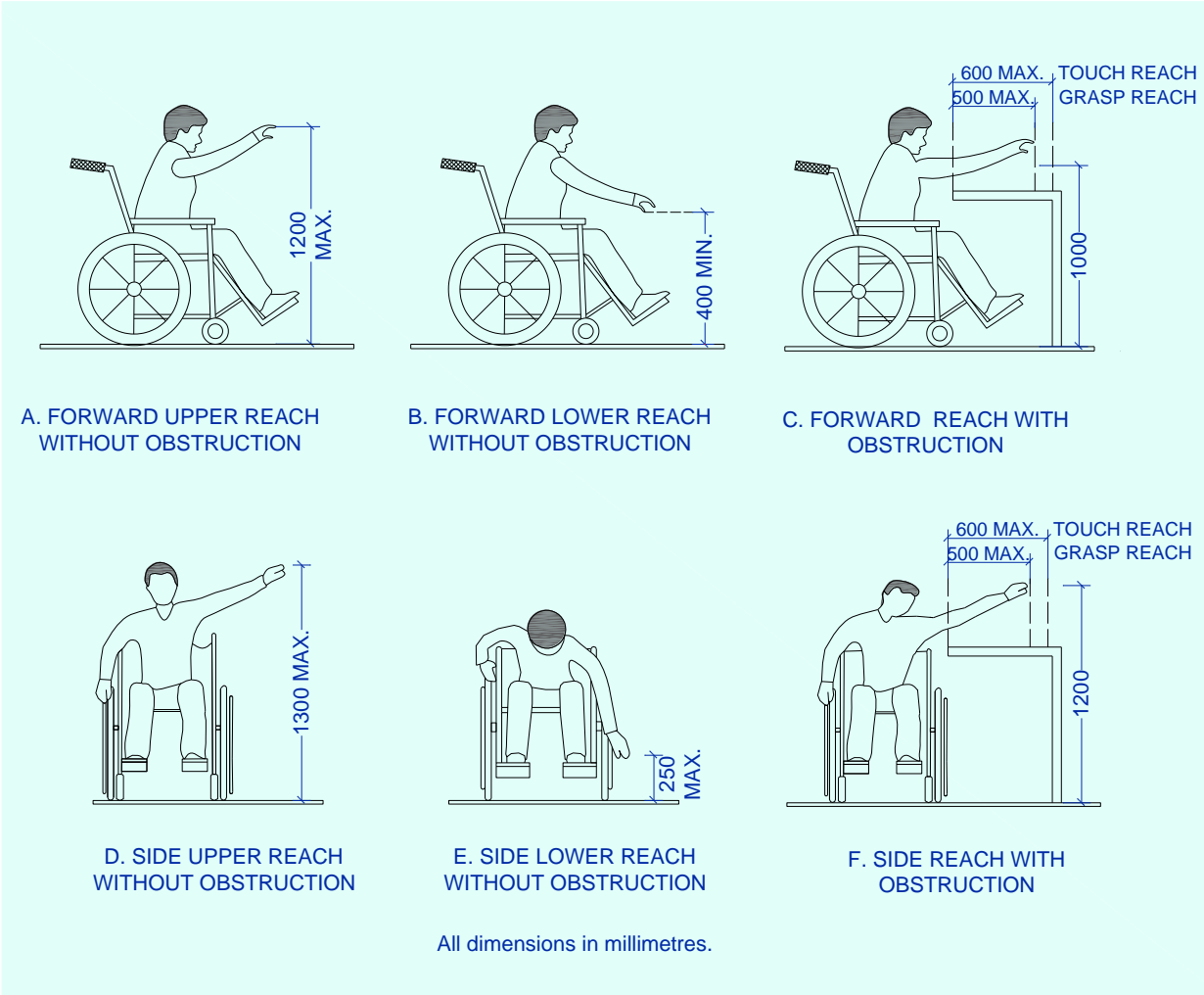

Figure 2: Reach Diagrams

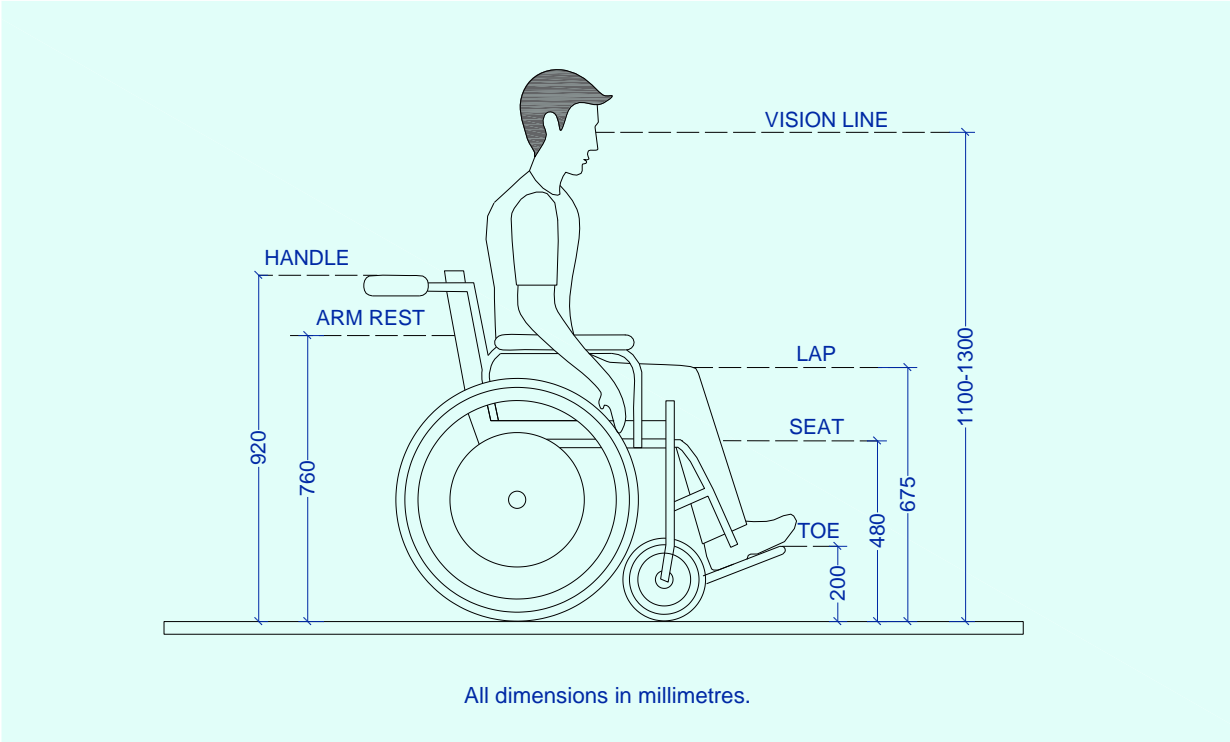
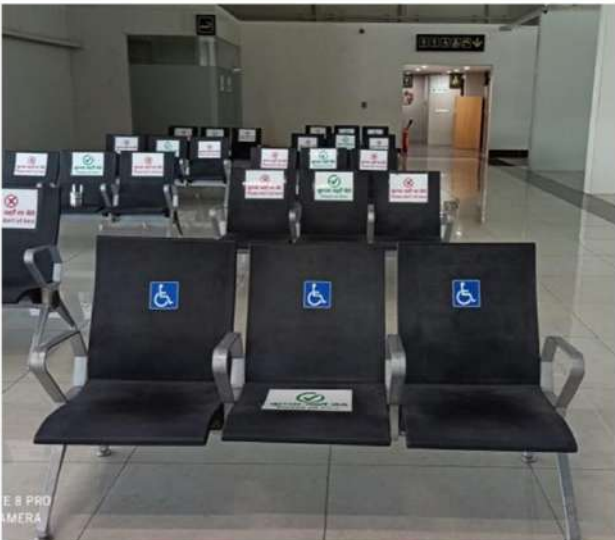

Figure 3: Dimensions of a wheelchair

Part A

Accessibility Features to be provided by Airport Operator





Part A: Accessibility Features to be provided by Airport Operator

1. Accessible Parking and drop-off/pick up point

1.1 Reserved parking **near terminal building** for persons with disability:

- i) Reserved parking should be provided for persons with disability next to the terminal building near the departure area and connected to the building entrance through an accessible route. Location of the parking should be such that the distance to the terminal entrance is minimum. No level changes to be present, where unavoidable, must be addressed by suitable accessibility features such as beveling, kerb ramp, ramp or an accessible lift.
- ii) The number of parking spaces to be given near the terminal area shall be calculated as per Table 1. [6]

Total number of car parking spaces in the parking lot	Required number of accessible parking bays
1-50	1
51-100	2
More than 100	Add an accessible parking bay at the rate of 1 per 200 parking spaces in the parking lot

Table 1: Number of reserved car parking spaces in parking lot

- iii) The minimum dimensions of the parking shall be 5400mm x 2500mm as shown in Figure 5.
- iv) A loading/unloading area (of minimum 1200mm width) shall be provided on the right side of each reserved parking space. Vehicles must be parked in one direction to utilize this loading /unloading area. Refer Figure 5. [7]
- v) On-floor signage (1200mm x 1200mm) of universal sign of accessibility in blue and white colour to be provided as per Figure 6 and Figure 10.
- vi) Vertical signage to be displayed at the reserved parking spaces as per Figure 46.
- vii) The loading/unloading area (also called the transfer bay) shall be painted with white diagonal lines as shown in Figure 6.

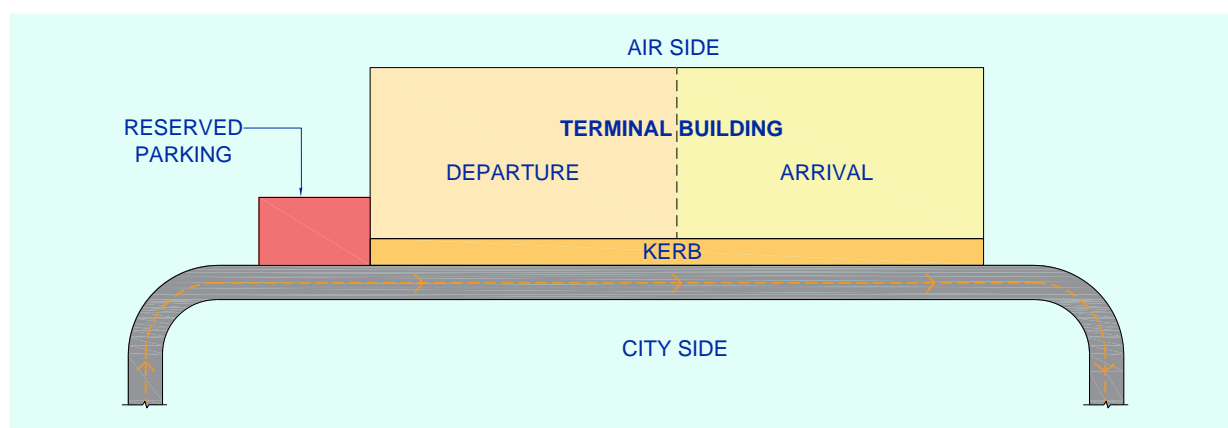

Figure 4: Schematic diagram showing the preferred location of reserved parking for persons with disability near terminal building

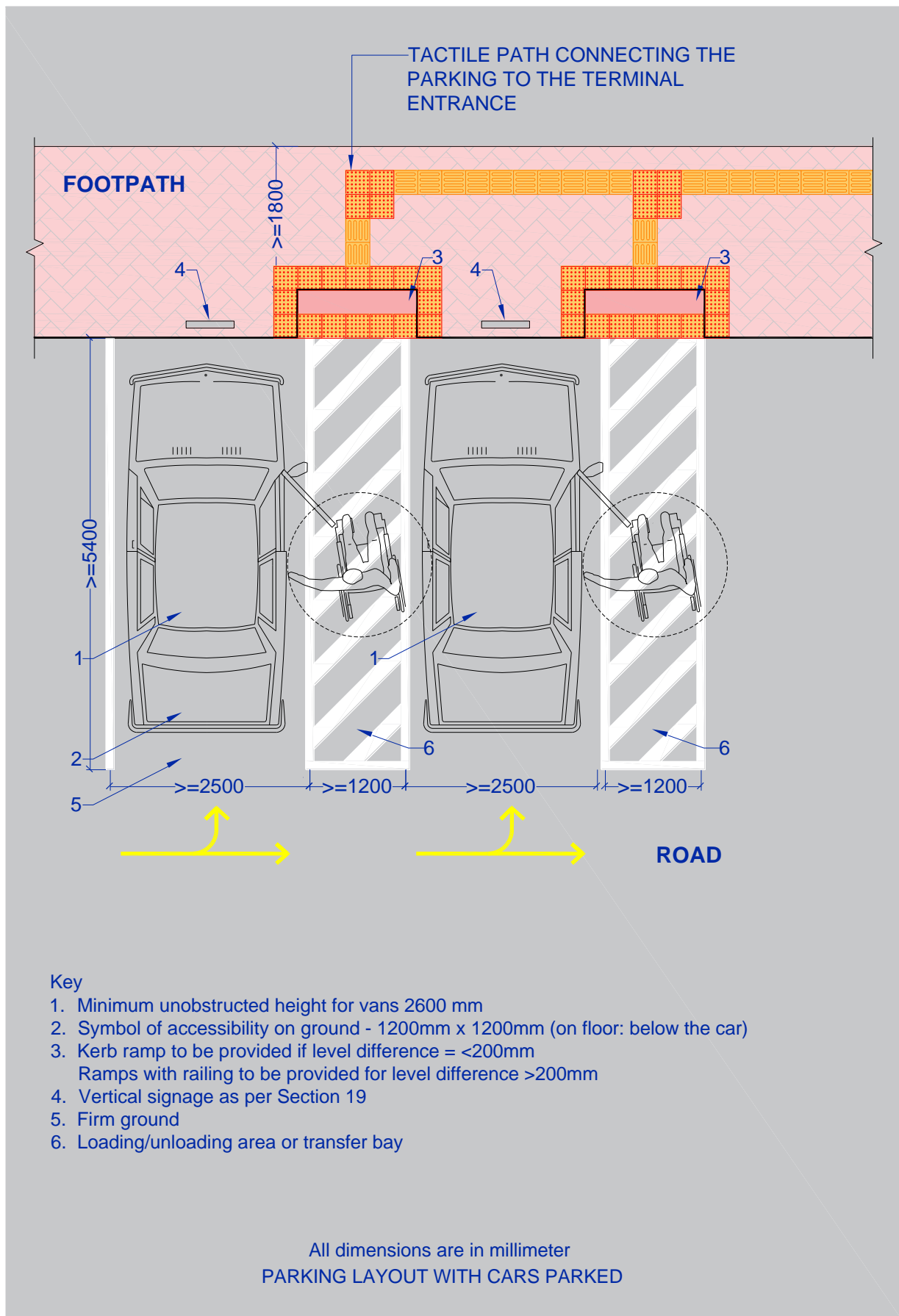

Figure 5: Reserved parking near terminal building for persons with disability

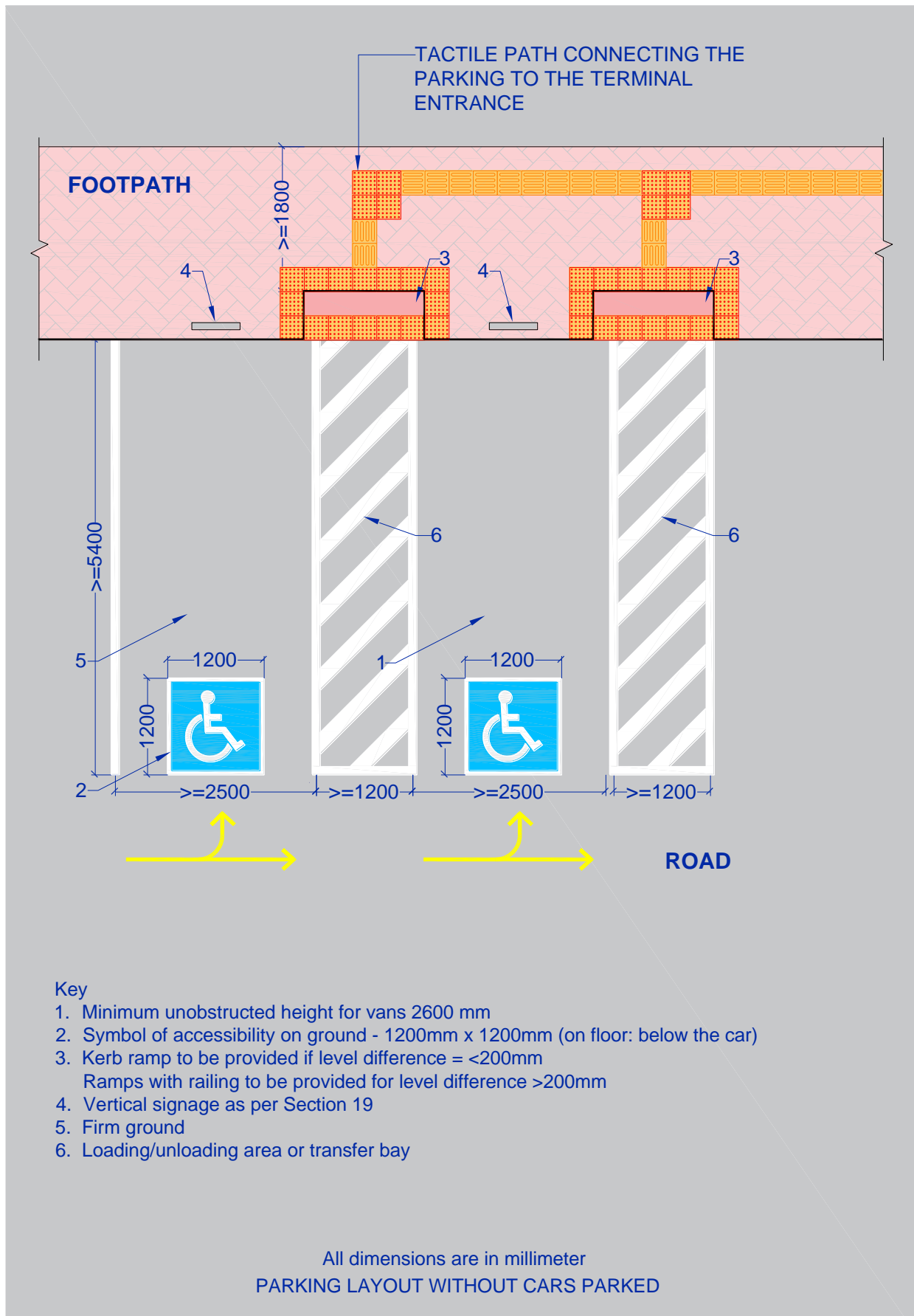

Figure 6: On-floor marking of reserved parking near terminal building for persons with disability



Image 1: Example of parking symbol on floor, transfer bay marking and kerb ramp

(Source: https://www.stripingtulsa.com/uploads/1/1/6/2/116266577/handicap-stall-and-crosshatch-tulsa-oklahoma_orig.jpg)

1.2 Pick-up and drop-off zone for persons with disability along the city-side kerb:

- i) One drop-off area in front of departure and one pick-up area in front of arrival of size 5000mm x 3600mm shall be provided along the city-side kerb as shown in Figure 8.
- ii) Vertical signage (600mm x 600mm) at a minimum height of 2400mm shall be provided as per Figure 7. Refer Figure 47 and Figure 48 in section 19 for signage.
- iii) On-floor signage (1200mm x 1200mm) of universal sign of accessibility shall be provided as per Figure 8 and Figure 9.
- iv) Accessible route (as per section 2) shall connect the pick-up and drop off zone to the terminal entry.

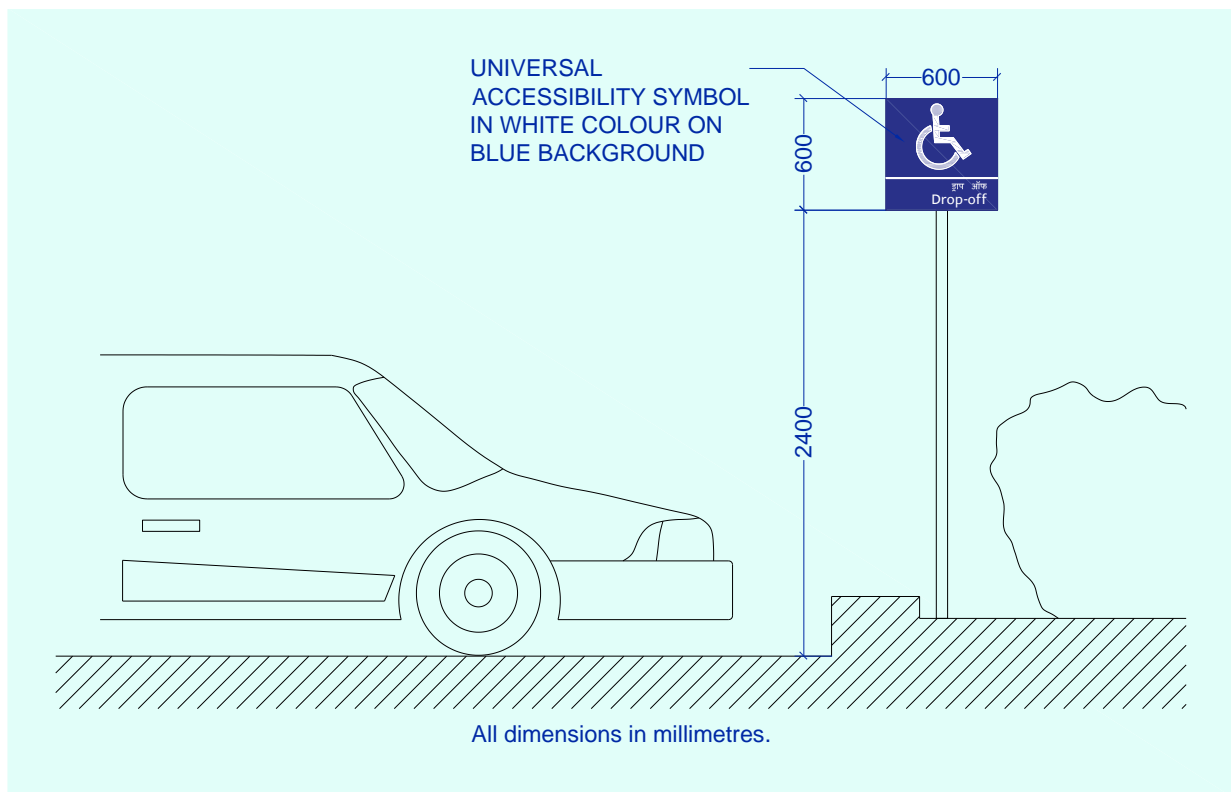

Figure 7: Vertical sign at City side kerb for accessible drop-off point

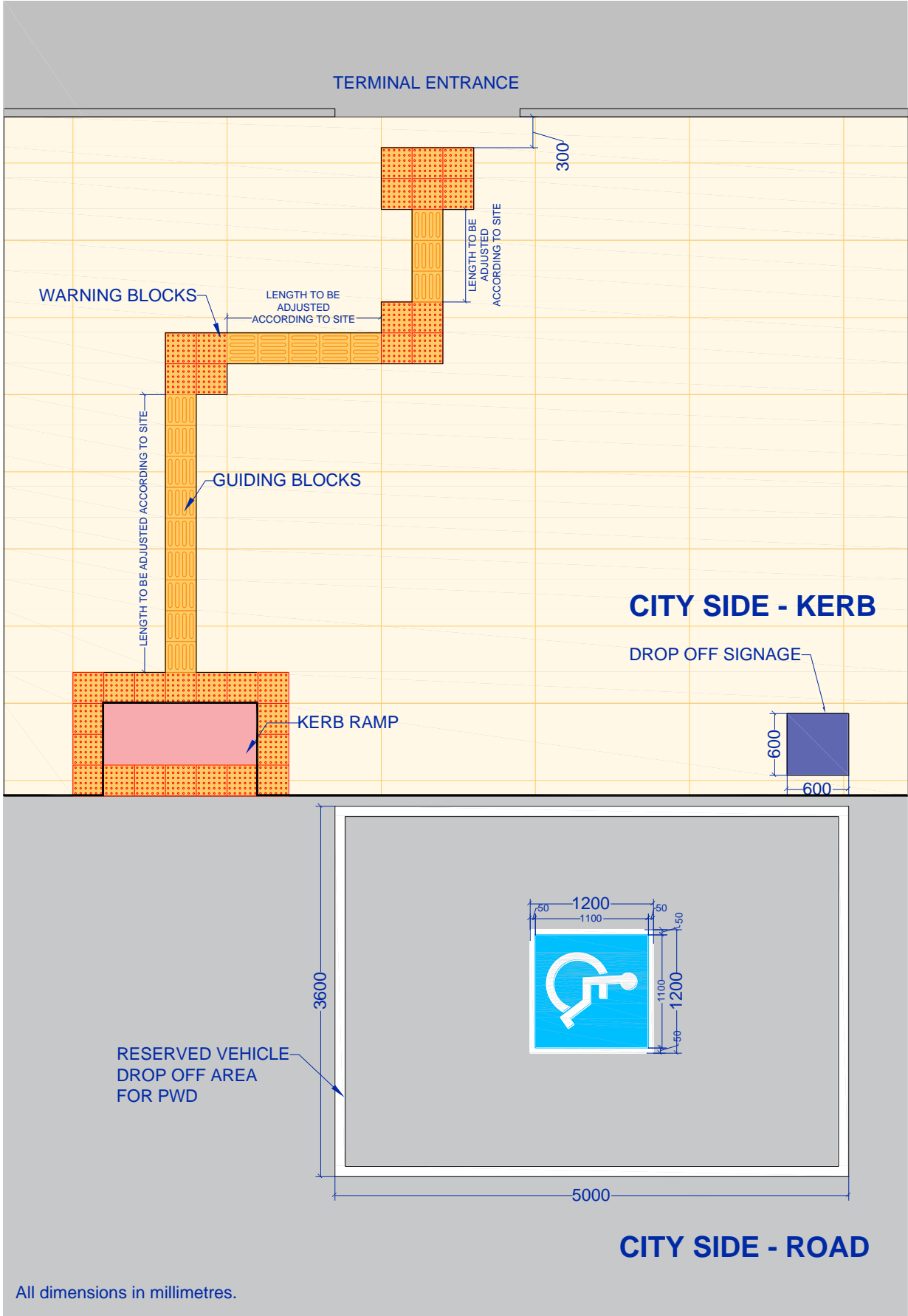

Figure 8: Example of guiding path from accessible drop-off/pick-up point on the city side kerb to the entry gate

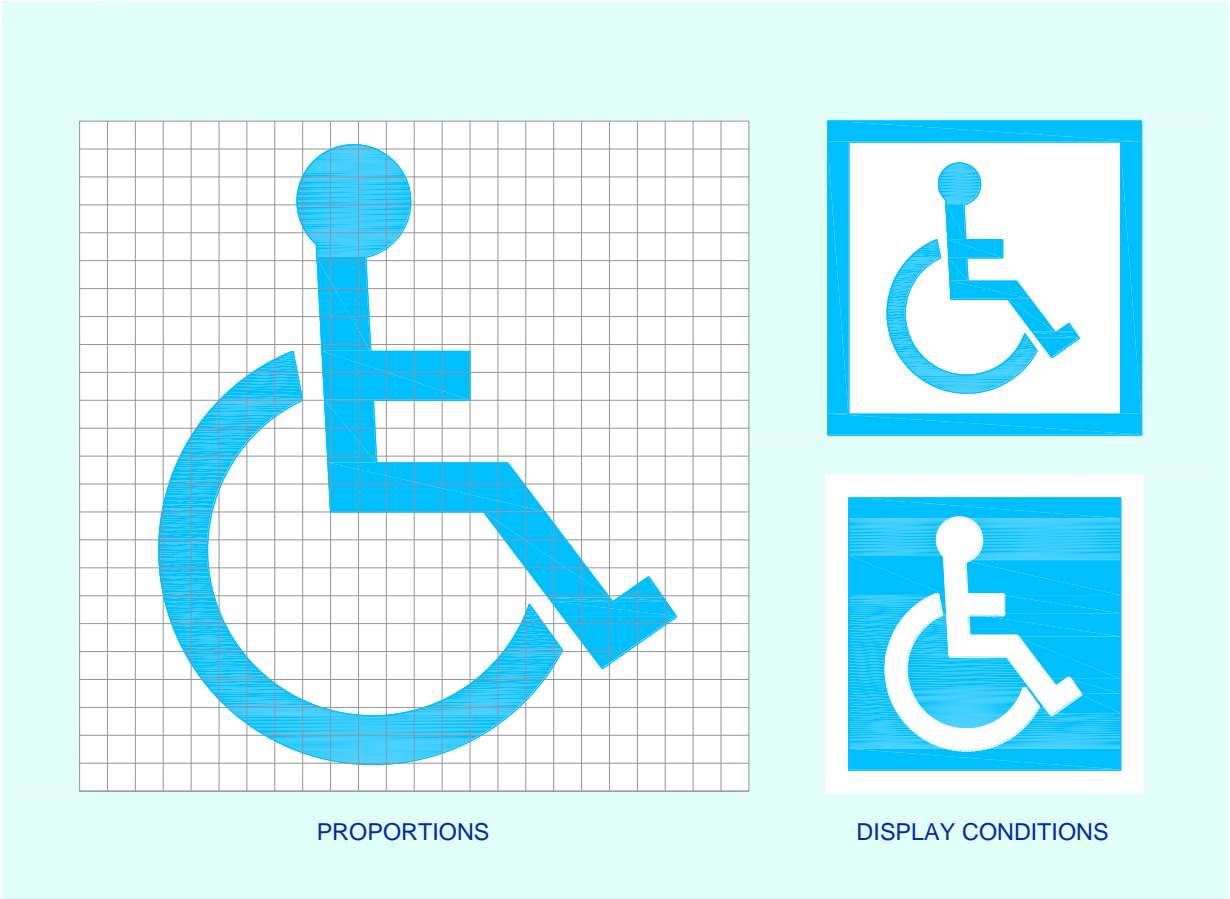

Figure 9: International Symbol of Accessibility

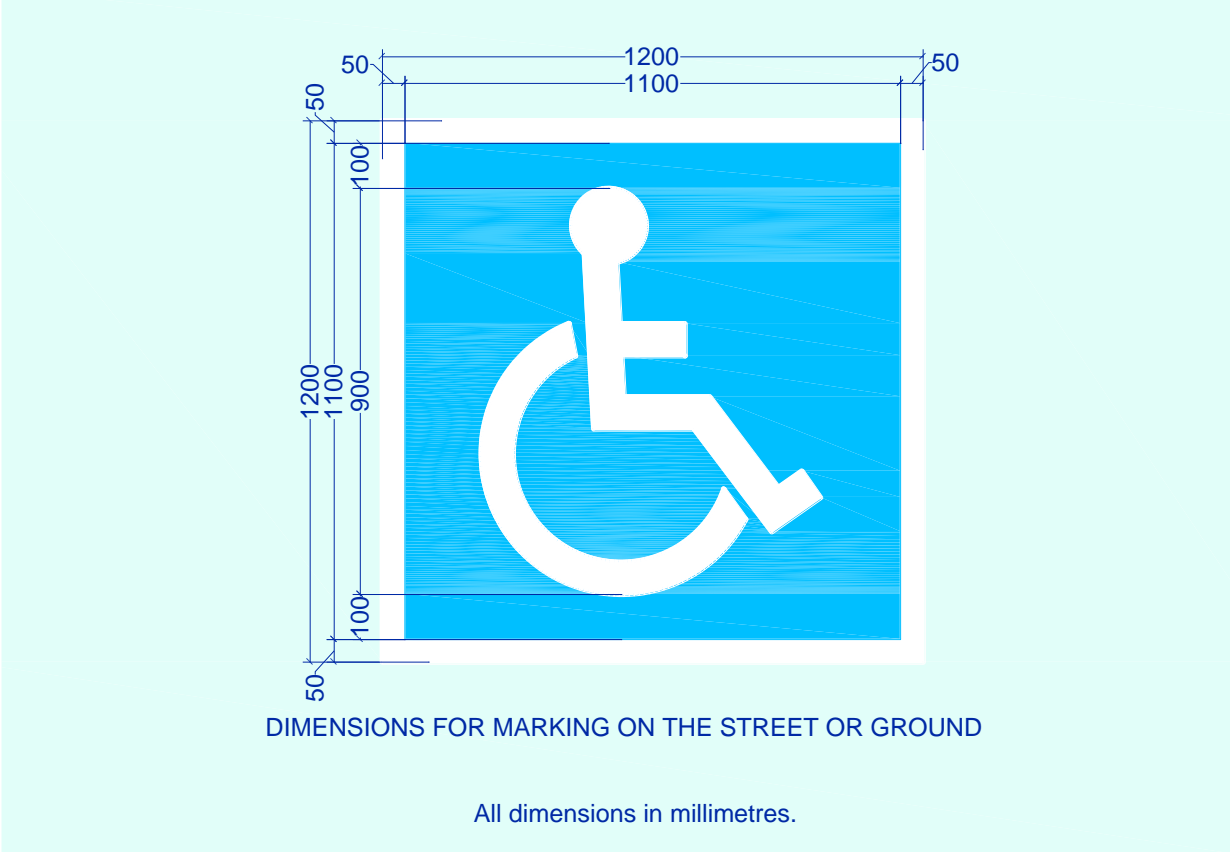

Figure 10: Details of on-floor International Symbol of Accessibility

2. Accessible Route/Approach

- 2.1 Passenger walkways, including road crossings near the city side, to be accessible [8]
- 2.2 Continuous tactile path connecting all accessible elements and spaces (like drop-off/ pick-up area, helpdesk, check-in counter, security check area, accessible lifts, ramps, accessible toilets, reserved seats, etc.) in a terminal building shall be provided [9]
- 2.3 Minimum Clear width of route shall be 1800mm for 2 wheelchairs / 900 mm for 1 wheelchair [9]
- 2.4 Anti-skid flooring (slip resistant with 'good' grading static coefficient of friction) shall be used [7].
- 2.5 Tactile material at least 300mm wide to be used for the path as per Section 11. [6]
- 2.6 Contrasting colour surface to be used for the tactile path for better visibility. [6]
- 2.7 Directional signage regarding accessibility features to be provided along the path. [9]
- 2.8 Wherever there is a level difference along the accessible route, a kerb ramp or ramp shall be provided as per Table 2 in section 3.
- 2.9 Slope, if any, along the accessible route (excluding the ramps), shall not have gradient greater than 5%. The walkway shall not have a gradient exceeding 1:20. It also refers to cross slope. [8]
- 2.10 Uneven surfaces shall be repaired and anything that encroaches on corridors or paths of travel shall be removed to avoid creating new barriers. Any obstructions or areas requiring maintenance shall be cane detectable and an alternate path should be made available. [8]

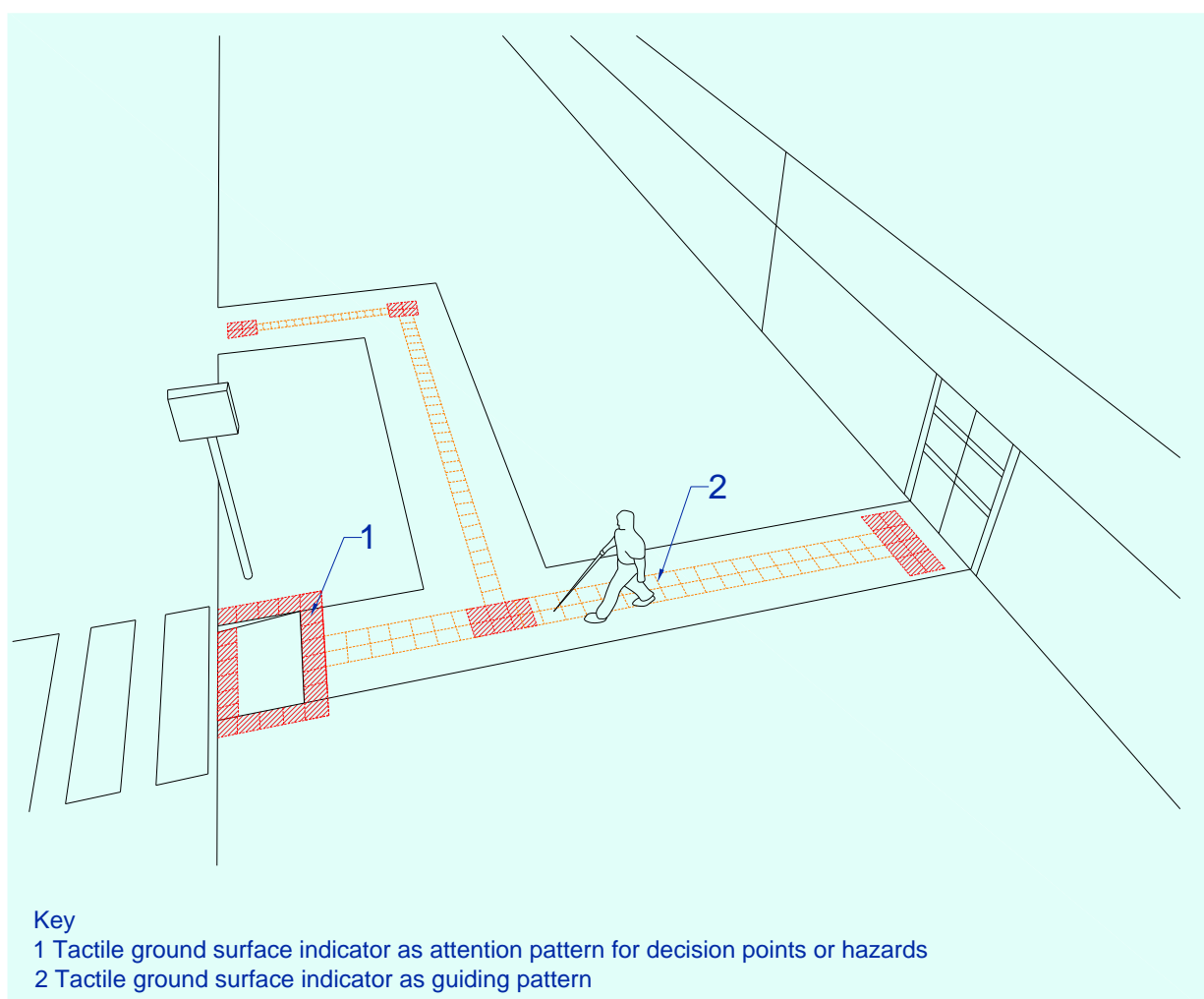

Figure 11: Example of tactile ground surface indicators used in open area (Source: NBC, 2016)

3. Accessible Entrance to the Building

- 3.1 The accessible route shall connect the drop off area along the city side kerb to at least one entrance of the departure block. Similarly, the accessible route shall connect pick-up area to one of the exit gates of arrival block. Refer Figure 8.
- 3.2 Ramps allow persons in wheelchair to move from one level to another. However, many ambulant Persons with Disabilities negotiate steps more easily and safely. Hence, it is ideal to provide accessibility by both steps and ramps.
- 3.3 Where the horizontal run of the approach ramp exceeds 9000 mm length, an alternative stepped approach, in addition to the ramp approach, shall be provided for people with ambulatory disabilities.
- 3.4 The entrance door shall have minimum clear width of 1000 mm [9]
- 3.5 If there is a level difference between the road level, kerb level and the entry gate then either a kerb ramp or ramp or lift to be provided as per the Table 2
- 3.6 Low height (700-900mm) telephone service to call the help desk for assistance to be provided at the city-side kerb near the drop off point for PRM. Signage to be provided above the telephone service as per Figure 49 in section 19. The location of this telephone should also be marked on the map, so that people can use navigation apps to get there without any additional support. [8]

Position of Entry/Exit gates of terminal with respect to drop-off/pick up zones and reserved parking	Level Difference (in mm)	Design Element to be used	Section to be referred for detail
Same Floor	0-200	Kerb Ramp	Section 13
	Above 200	Ramp with railings	Section 13
Different Floors	-	Accessible lift	Section 12

Table 2: Design elements to be used for difference in floor levels

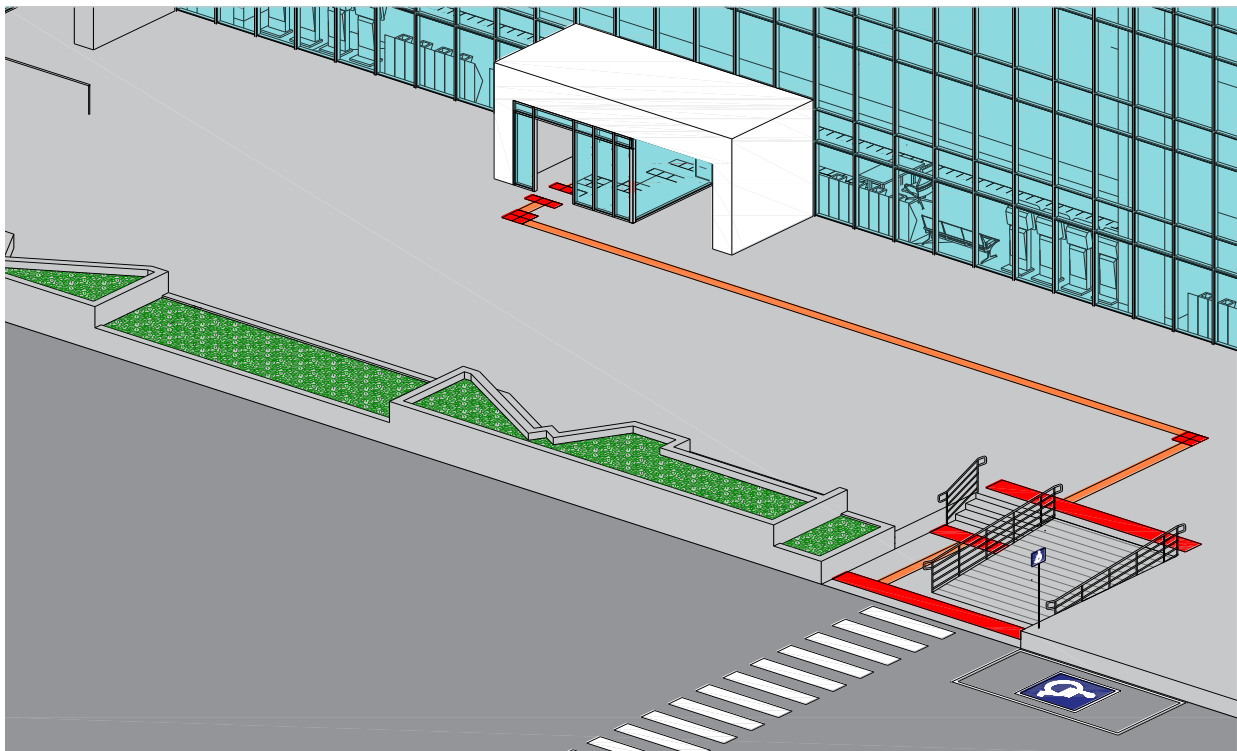

Figure 12: Example of an accessible approach with ramp and stairs connecting the drop off zone to entry gate

4. Accessible Reception (Helpdesk)

- 4.1 A helpdesk shall be provided near the entry gate along the accessible route in the departure block. It would cater to the people just starting their journey. Similarly, a helpdesk shall be given in the arrival lobby near the entry gates (airside) along the accessible corridor to assist passengers going to the baggage claim area.
- 4.2 Helpdesk with counters at two heights shall be provided with one counter at 800mm and other at a higher level of 1100mm. Refer detailed drawing attached in **Annexure B**. [9]
- 4.3 Minimum unobstructed space before the counter to be 900mm x 1200mm [9]
- 4.4 Clear leg space below counter to be at least 800mm wide and 700mm in height [9]
- 4.5 Depth of counter should be 550mm for closer reach to commuter [9]
- 4.6 Induction loop should be provided for persons with hearing impairment [9]
- 4.7 Information to be made available regarding accessible features of the building at the helpdesk (washrooms, drinking water etc.) [9]
- 4.8 Tactile/Audio maps of the airport building for directions should be provided at the helpdesk. A tactile map of the airport (showing all the important points of interest) for way finding with braille in three languages (Hindi, English and the local language) to be provided at the help desk. Examples are shown in Image 2, Image 3 and Image 4 [9]
- 4.9 'Airport Help' signage to be put up near the counter as per Figure 51 in Section 19 [9]
- 4.10 All personnel on help desk to be given training to communicate efficiently with all the people with disabilities including training on sign language.
- 4.11 A groove to be provided on the desk side, to fix the guiding stick people carry.
- 4.12 Volunteers wearing AIC badges to be available to assist people with reduced mobility as shown in Image 5.
- 4.13 Maximum reach of wheelchair users to be considered (refer Figure 2) for designing the counters. All forms, information booklets, etc. to be kept within their reach. [10]
- 4.14 Airports to maintain statistics of number of PRM using the airport and various services.

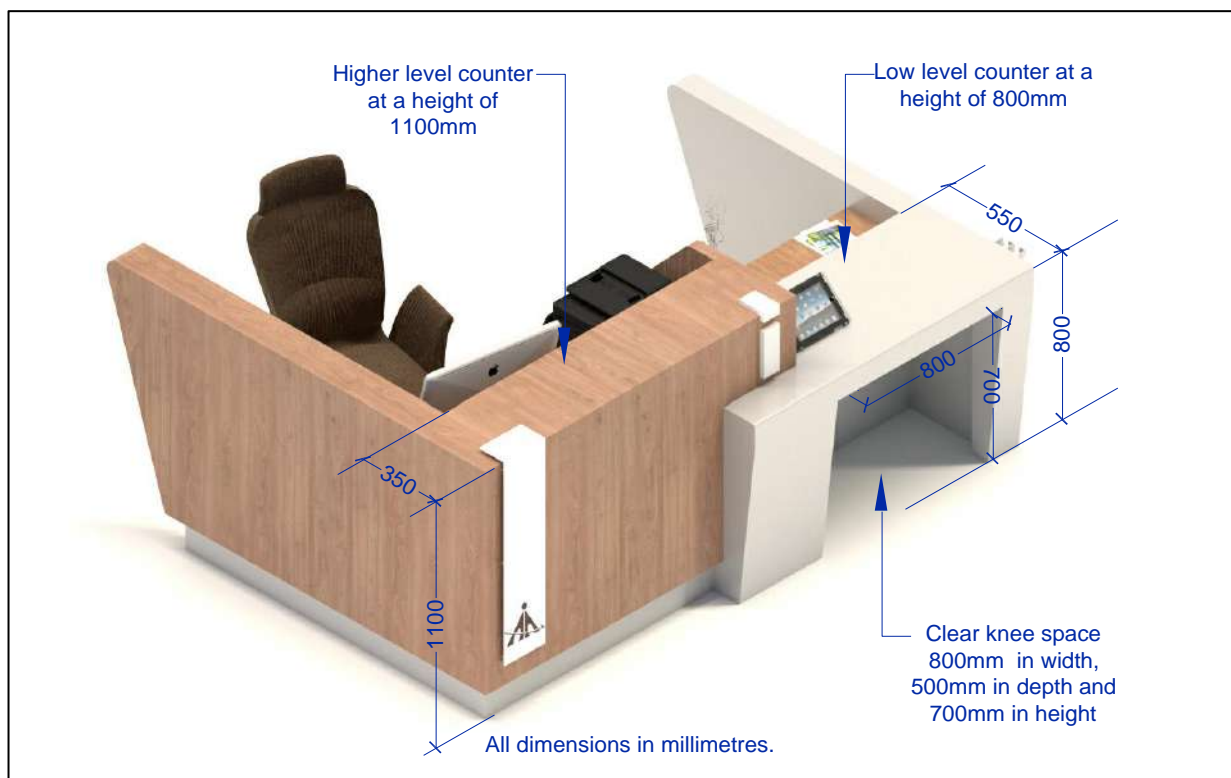

Figure 13: Typical Helpdesk design for ease of wheelchair users



Image 2: Large Tactile Floor Plan at one of the entrances to the terminal building at Ciampino Airport in Rome, Italy (Source: <https://cjwalsh.ie/2012/11/>)

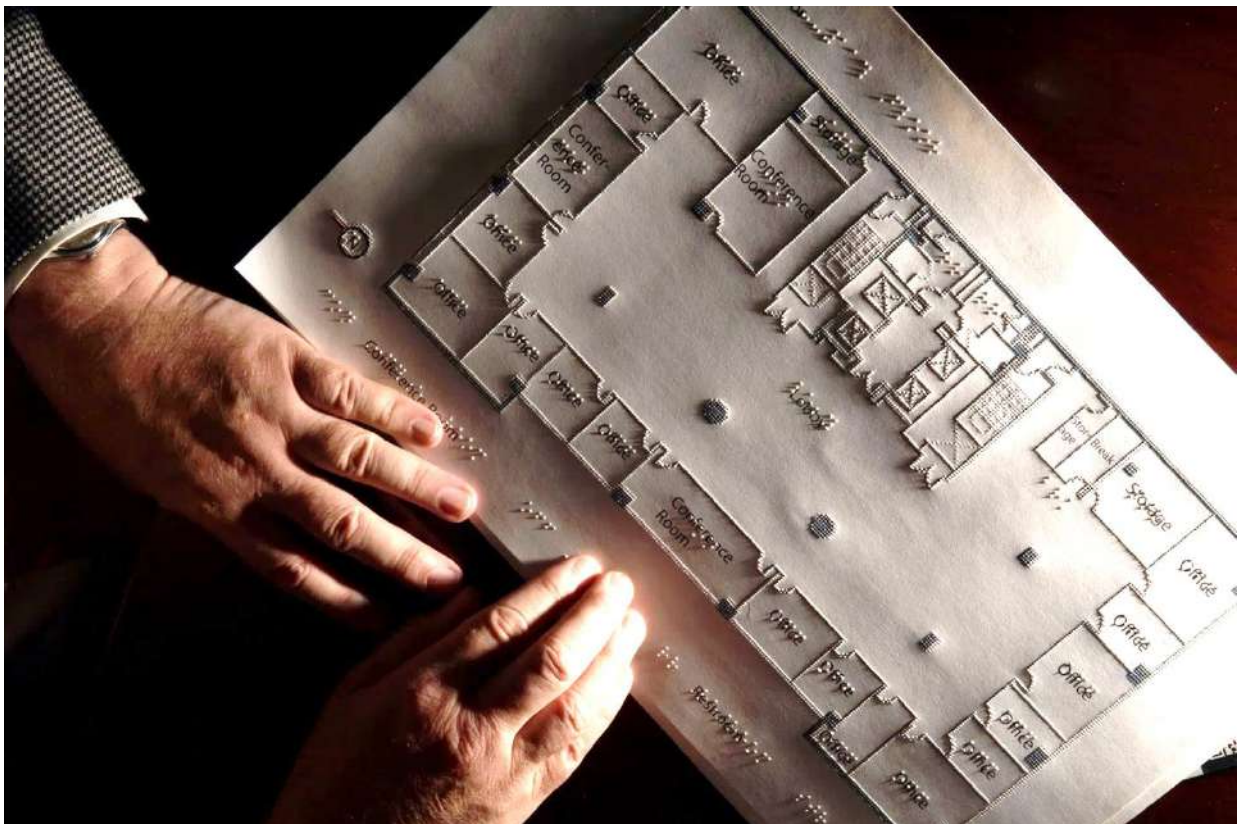

Image 3: Example of tactile map of building to be displayed near the reception desk (Source: https://1.bp.blogspot.com/-QVrUXmSQPMc/Vbeip_2lmyl/AAAAAAAAHKE/TtCouHcBfAk/s1600/tactile_map.jpg)



Image 4: Example of Braille sign map and tactile facility at Mysuru Railway Station (Source: <https://pbs.twimg.com/media/C7WPgtYVwAALEov.jpg>)



Image 5: Accessible India Campaign badges to be worn by volunteers at the airport

5. Check-in area

- 5.1 Minimum unobstructed space before the check-in counter to be 900mm x 1200mm [9]
- 5.2 In smaller airports, at least one check-in counter shall be accessible by wheelchair and marked for priority treatment to people with reduced mobility. A single row of warning tiles in front of the check-in counters and connected to the accessible route tactile flooring as shown in Figure 14.
- 5.3 In bigger airports with dedicated islands for different airlines, one counter from each airline island shall be marked as an accessible check-in counter. Starting point of each check-in counter island to be connected to the accessible route tactile flooring as shown in Figure 15.
- 5.4 At least one self-check in counter shall be accessible by wheelchair and marked for priority treatment to people with reduced mobility.
- 5.5 Signage of priority counter shall be displayed on the accessible counters to demarcate them (refer Figure 52).

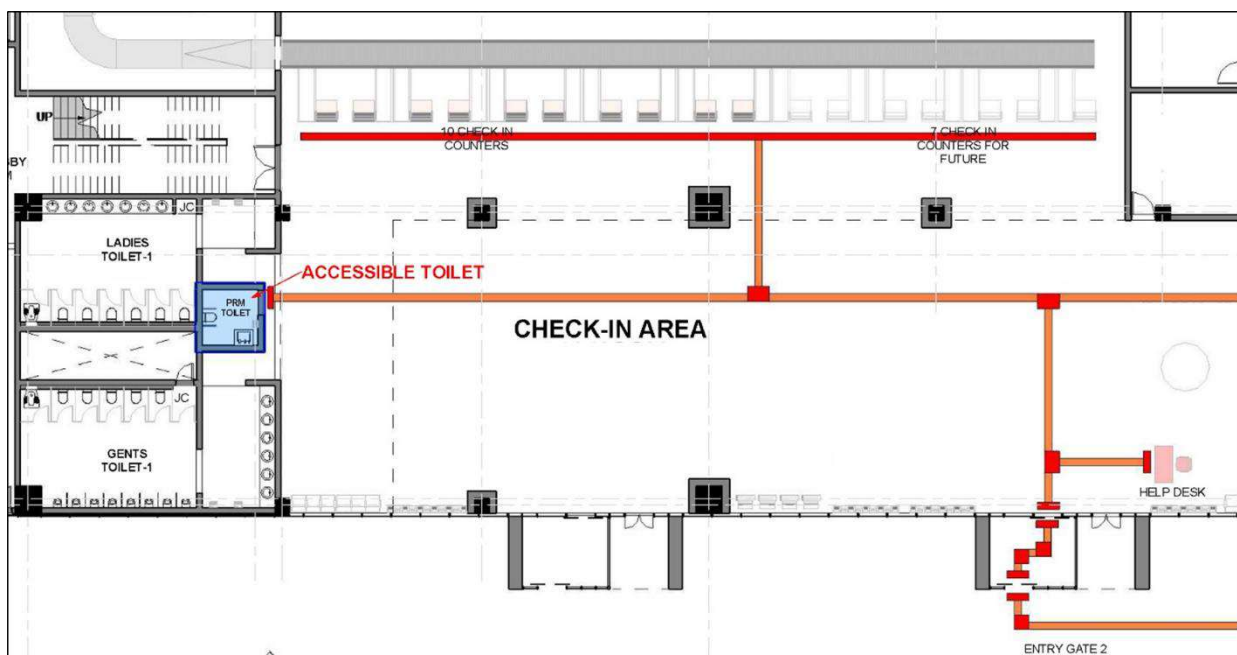

Figure 14: Example of warning tiles in front of check-in counters in small airports

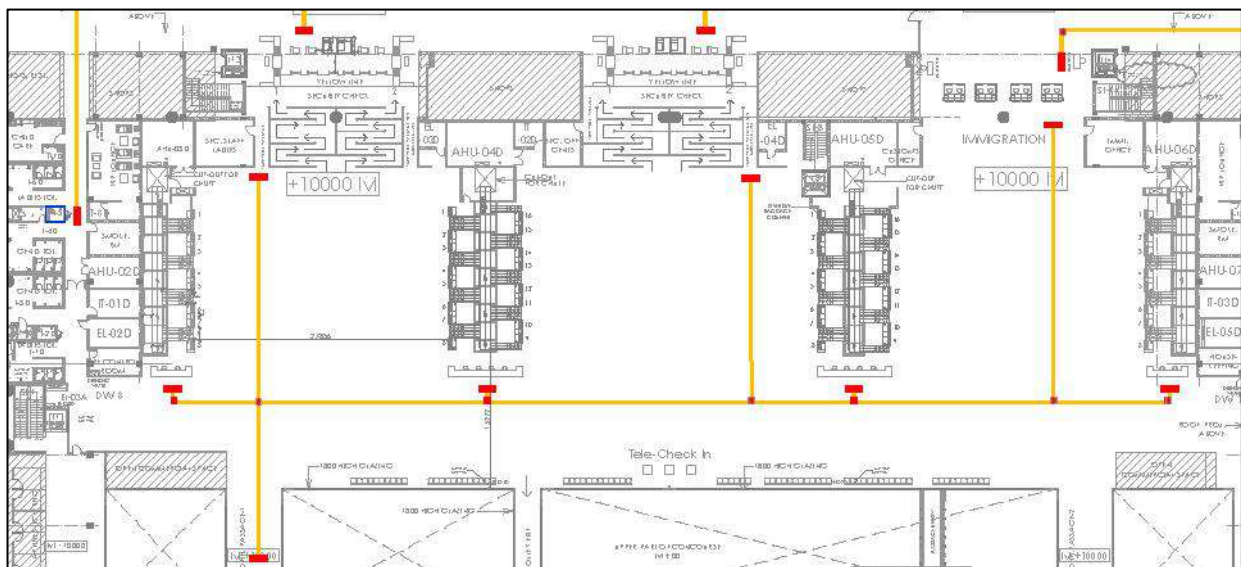

Figure 15: Example of accessible route connecting each check-in counter island in big airports



Image 6: Priority Check-in for people with reduced mobility

(Source: https://www.ridc.org.uk/sites/default/files/styles/lead_image_content_desktop/public/field/image/lead/airport-heathrow-checkin.jpg?itok=sMNIZ8WZ)



Image 7: Example of required toe space below the priority check in counter and signage example
(Source: <https://www.vantagemobility.com/wp-content/uploads/VMI-AirportAccessible-LP.png>)

6. Security Check

- 6.1 One lane for males and one lane for females to give priority treatment to persons with disability shall be marked. The lane should not be reserved for them, instead used for giving them priority treatment. Frisking cubicle of standard size (minimum 1500mm x 1500mm for wheelchair turning) shall be given for both these lanes, male as well as female (for frisking people with amputation, etc.).
- 6.2 The person in charge of the counter should be given training to communicate efficiently with all the people with disabilities including training on sign language.
- 6.3 The DFMD panel of minimum 1000mm width shall be provided in these two lanes. [11]
- 6.4 'Priority Lane' signage (similar to Figure 52) should be displayed at the beginning of these two lanes for easy identification [11]

7. Accessible Corridor (Main passenger movement zone)

- 7.1 Minimum clear width of the corridor to be kept free of any obstacles such as plantation, seating arrangements, etc.
- 7.2 The minimum clear width of 1200 mm is recommended for a one-way travel direction for persons using wheelchairs or others with high support needs. [6]
- 7.3 The minimum clear width of an accessible route should be 1500mm to allow both a wheelchair and a walking person to pass except when additional manoeuvring space is required at doorways. [6]
- 7.4 Where space is required for two wheelchairs to pass, the minimum clear width should be 1800mm [6]
- 7.5 Tactile guiding path shall be provided in the corridor along the accessible route connecting the important facilities as per section 11.
- 7.6 Corridors to be well lit with natural/artificial lighting (300 lux) [9]
- 7.7 Directional and informational signage to be provided along the corridors. [9]
- 7.8 Handrails/ Grab bars should be provided wherever possible as per section 15.
- 7.9 All the doors to open out from the corridor so as to keep the corridors unobstructed. [9]
- 7.10 Red strips to be given along the tactile path for people with partial visual impairment. [9]
- 7.11 Self illuminating strips may be provided along the corridor.
- 7.12 Uneven surfaces should be repaired and anything that encroaches on corridors or paths of travel shall be removed to avoid creating new barriers. Any obstructions or areas requiring maintenance shall be cane detectable. [8]
- 7.13 Changes in level in the corridors should be treated with a slope as per Table 4.

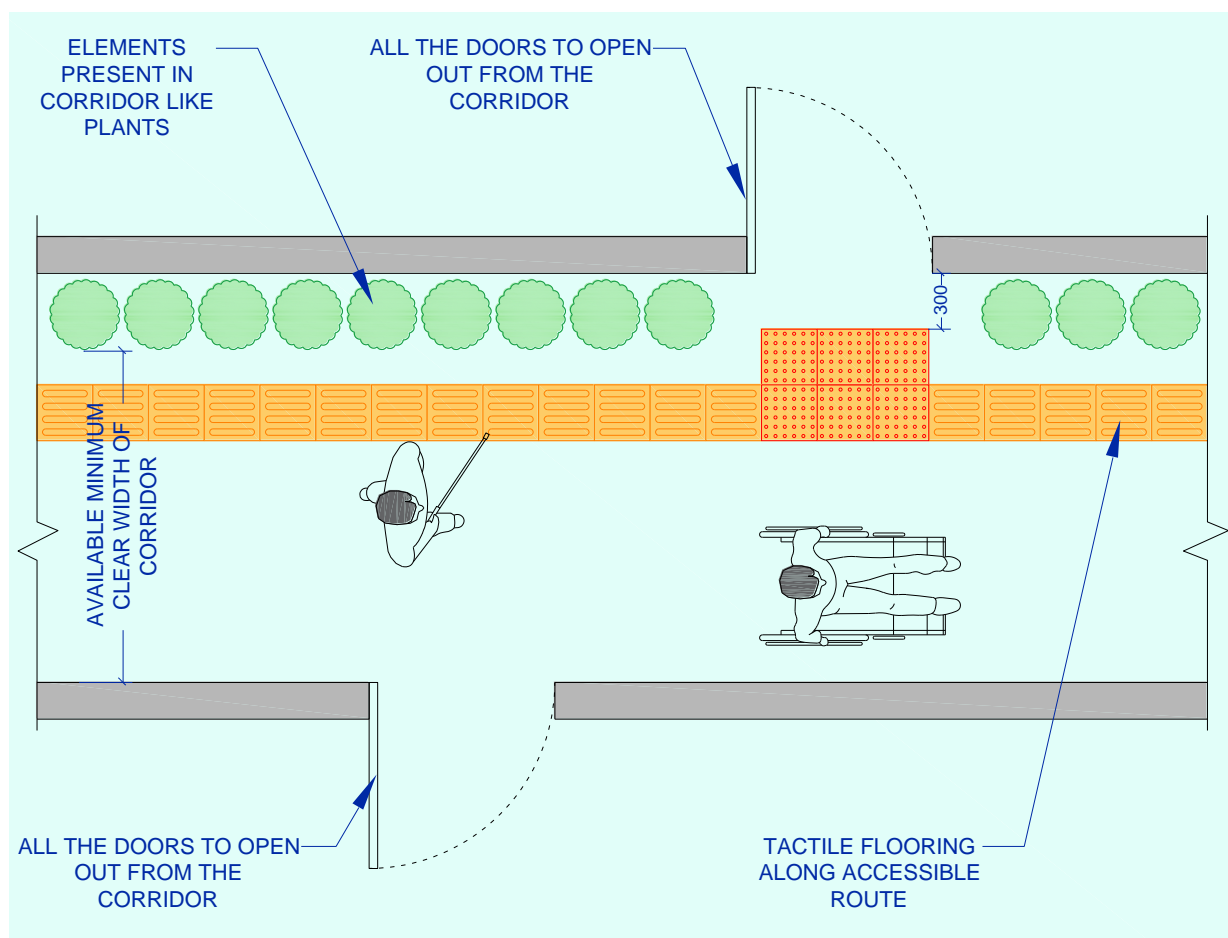

Figure 16: Preferred width of corridor

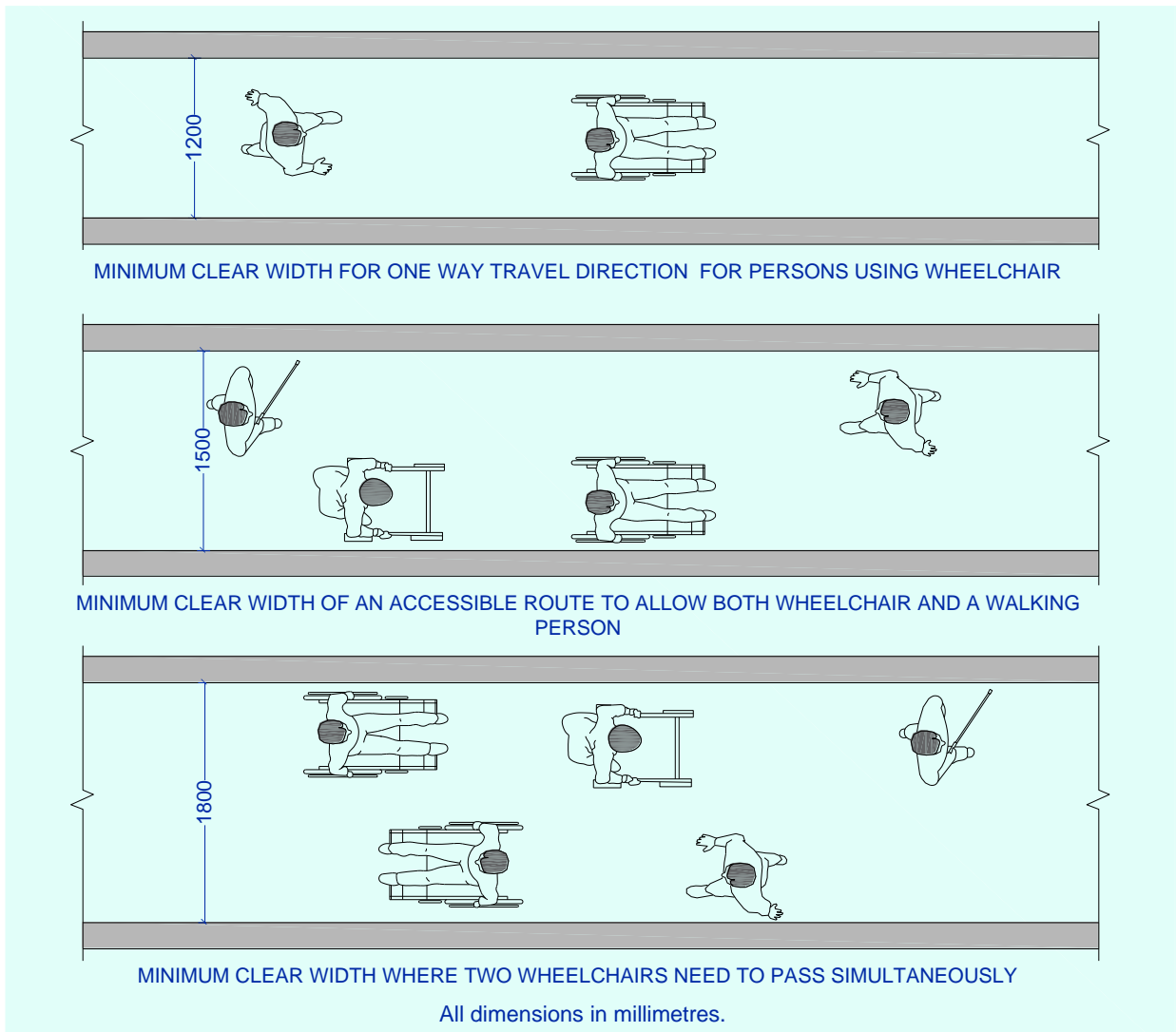

Figure 17: Minimum Clear width requirement of accessible corridors

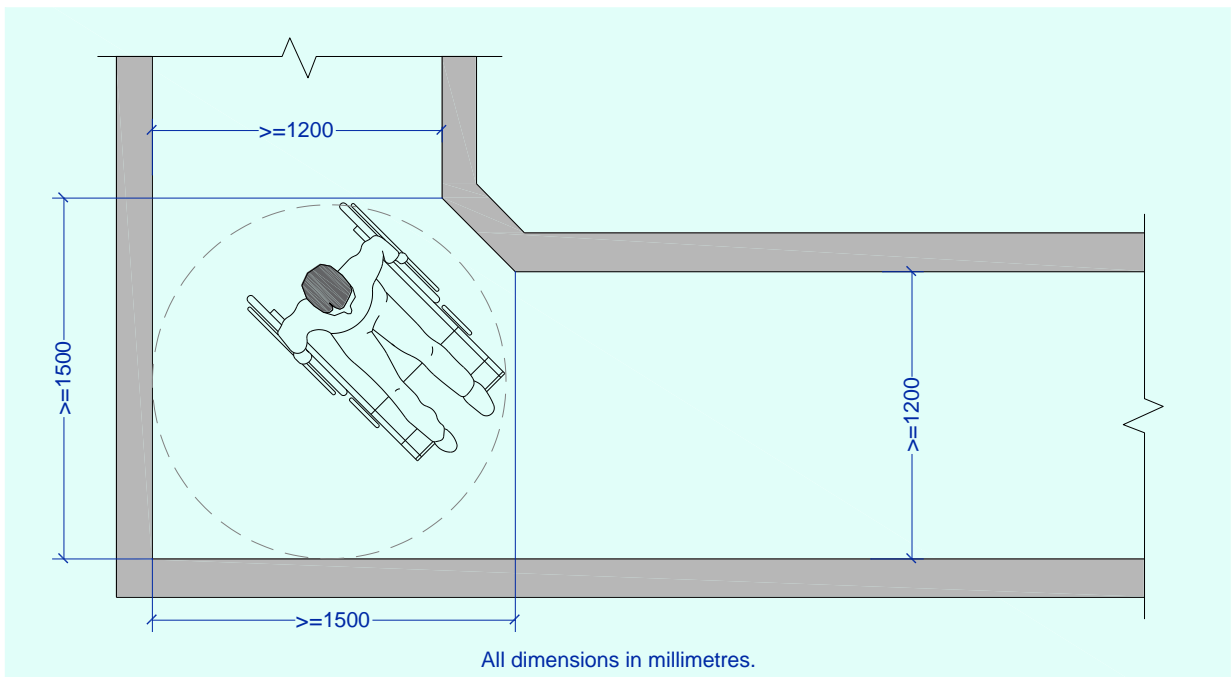

Figure 18: Space requirement for right angled turn in an accessible corridor

8. Baggage Claim

- 8.1 Demarcation of priority space of size 1500 x 1500mm as per Figure 20 shall be done for persons with disability near each baggage claim belt.
- 8.2 The marking should be easily visible from the arrival corridor and arrival hall gates.
- 8.3 The marking near each baggage belt shall be connected to the accessible route tactile flooring as shown in Figure 19.
- 8.4 Assistance to be provided by the airlines to passengers requiring assistance for picking up the luggage.
- 8.5 Universal symbol of accessibility to be marked on the ground along the straight part of the baggage belt, near the end closer to the exit gates as shown in Figure 19 and Figure 20.

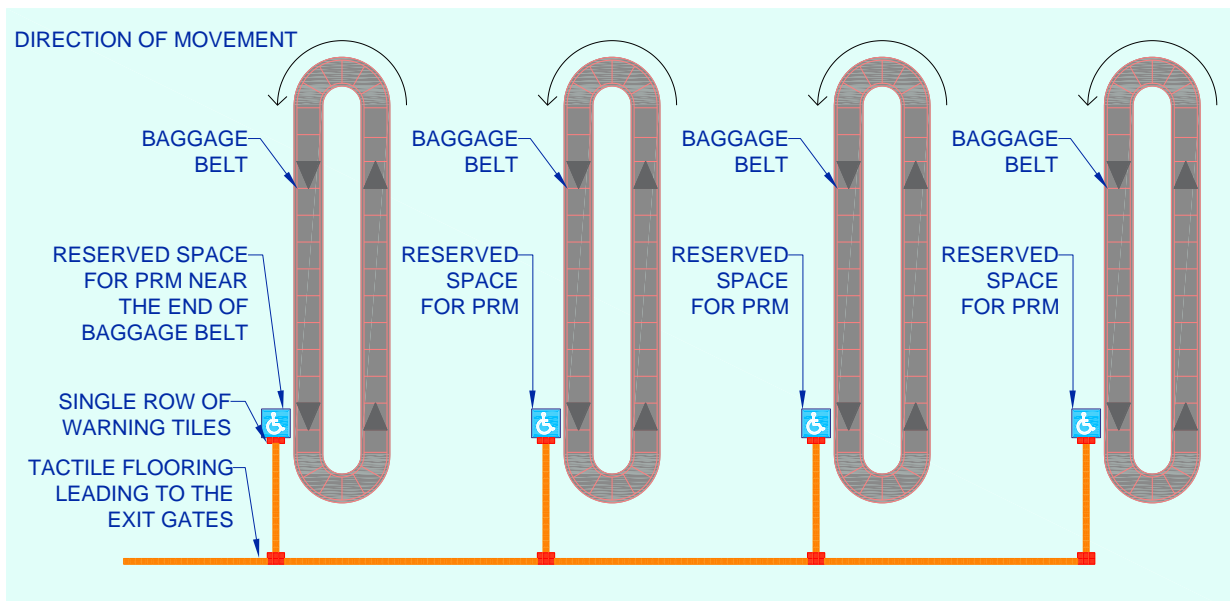

Figure 19: Location of Universal Symbol of Accessibility marking on ground

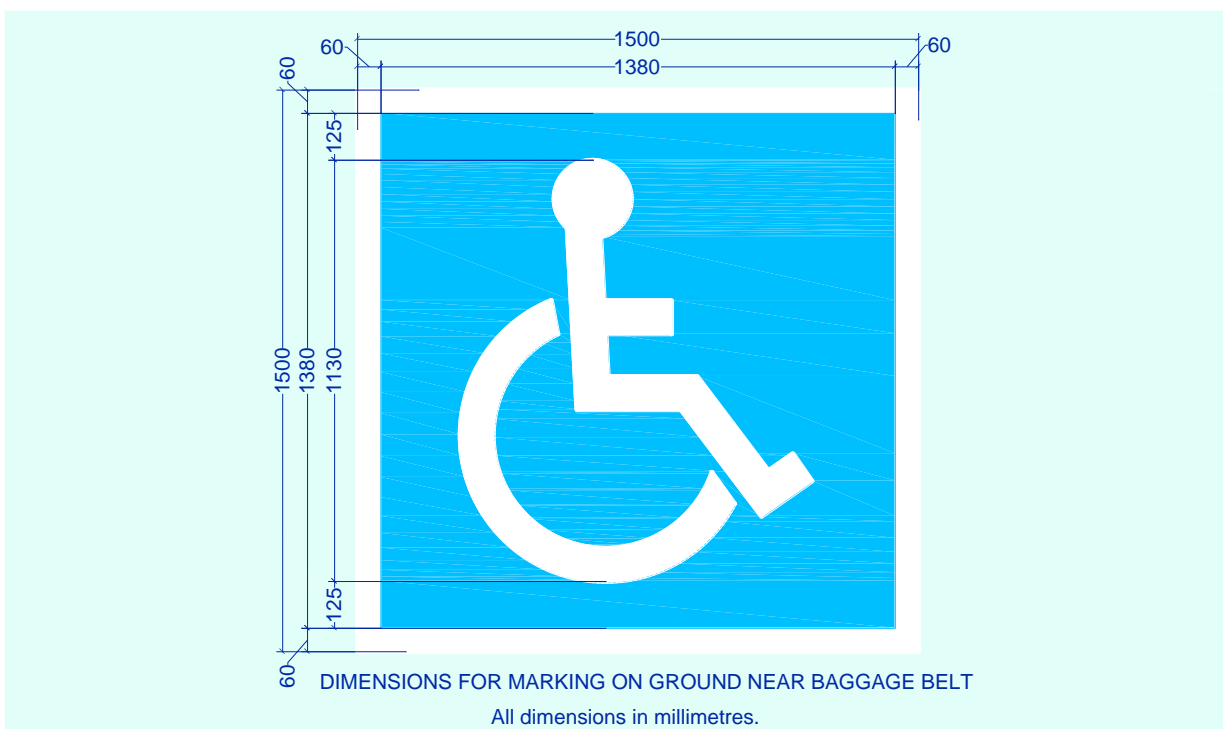

Figure 20: Details of on-floor International Symbol of Accessibility for Baggage Claim Area

9. Seating Spaces

- 9.1 Designated seating shall be provided for passengers with disabilities in check-in area, and in the security hold area near the boarding gates (at least 3 chairs near each gate) within viewing distance of communication boards, and within hearing range of audio announcements as well. [8]
- 9.2 Terminal operators should provide seating in passenger service areas where there may be long waiting lines or times, including at ticket sales counters, check-in counters, immigration counters, secured screening and customs counters, outside toilet blocks and baggage retrieval areas. [8]
- 9.3 Such seating areas should be preferably corner seats identified by the universal symbol of accessibility and with foldable/removable armrest to allow passengers with disabilities who want to transfer from wheelchairs to these reserved seats for posture change. Shelter should be provided where this seating is outdoors. [8]
- 9.4 A single row of warning tiles shall be provided in front of the reserved seats and to be connected to the accessible route as shown in Figure 21 and Figure 22.

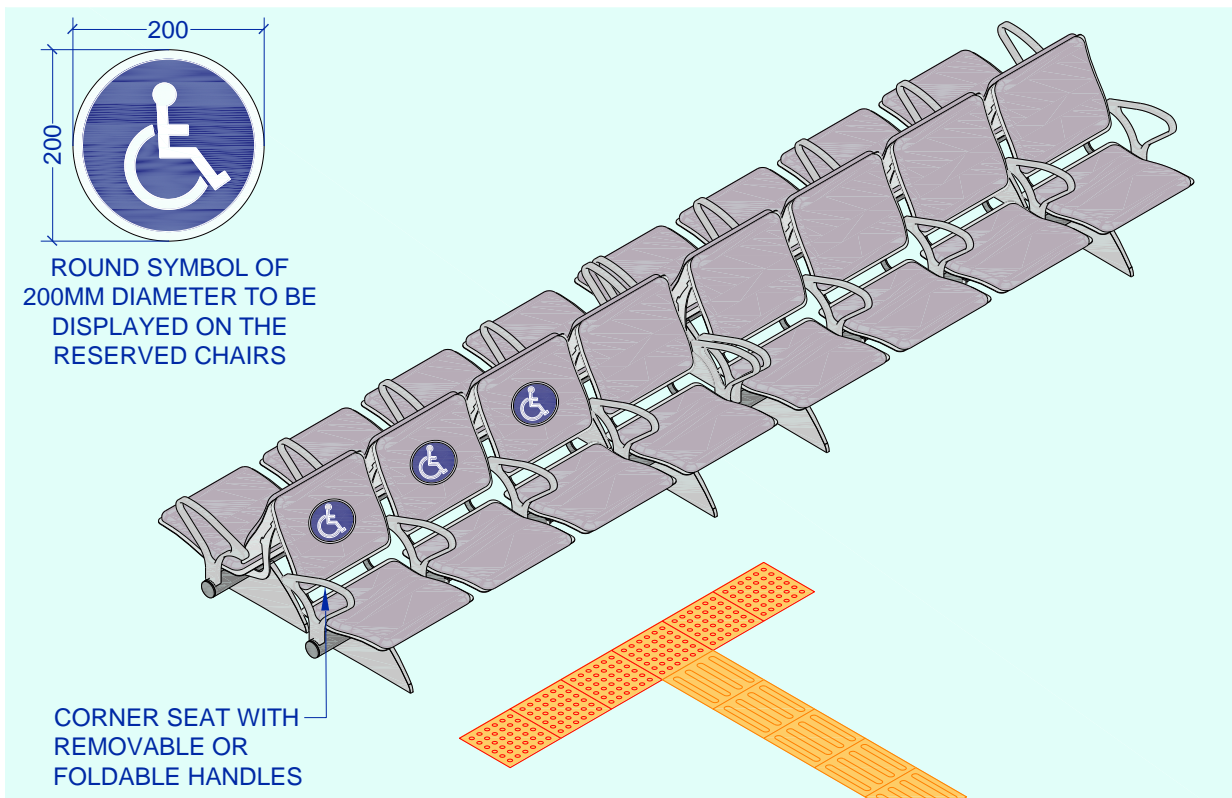

Figure 21: Reserved seating with tactile flooring in front

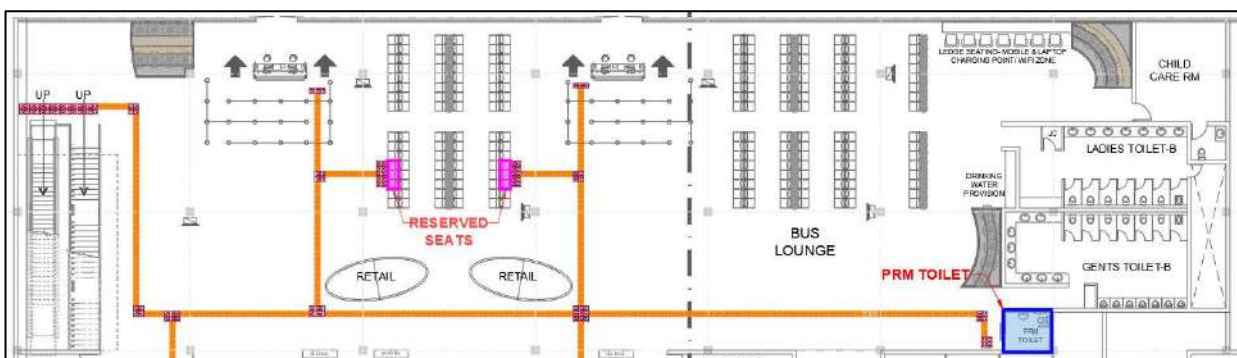

Figure 22: Example of reserved seats for PRM near each boarding gate

10. Immigration and Custom

- 10.1 At least one counter to be accessible by wheelchair and marked for priority treatment to persons with disability. The counter should not be reserved for them, instead used for giving them priority treatment. The person in charge of the counter should be given training to communicate efficiently with all the people with disabilities including training on sign language.
- 10.2 Priority Counter signage of 700mm x 600mm (refer Figure 52) should be displayed at the beginning of these two lanes for easy identification [11]

11. Tactile Ground Surface Indicators (TGSi)

- 11.1 Tactile ground surface indicators or tactile guiding and warning tiles/blocks aid blind and vision impaired pedestrians negotiate the built environment, and shall be of the dimensions as given in Figure 23.
- 11.2 TGSi shall be installed along the accessible route connecting all the accessible spaces inside and outside the terminal building as mentioned in Section 2.2.
- 11.3 Two types of tiles are to be used:
- Guiding blocks –
These blocks indicate a correct path/route to follow for a person with visual impairment (Figure 23). It is recommended to install one row of tactile guidance tiles **along** the entire length of the proposed accessible route. Also, there shall be clear headroom of at least 2.1 m height above the tactile guidance blocks, free of protruding objects such as overhanging tree branches and signage, along the entire length of the walk. [10]
 - Warning blocks –
This block indicates a change in direction of the walkway or an approaching potential hazard, and serves as a warning of the approaching danger (Figure 23). They are used to screen off obstacles, drop-offs or other hazards, to discourage movement in an incorrect direction, and to warn of a corner or junction. One/two rows of tactile warning tiles shall be installed **across** the entire width of the designated accessible pathway before road crossings, escalators, level changes, obstacles such as trees, and each time the walkway changes direction. Warning blocks shall be placed at 300mm from the beginning and end of the ramps & stairs, at landings and entrance to any door. [10]
- 11.4 Different configurations of the warning tiles are to be used at intersections depending on the number of paths as shown in Figure 24
- 11.5 Warning tiles shall be provided in front of the following elements:
- helpdesk and accessible counters
 - lift openings (refer section 12, Figure 26)
 - ramps (refer section 13, Figure 27, Figure 29, Figure 30)
 - staircase (refer section 14, Figure 32Figure 25)
 - door openings (refer section 11, Figure 25)
 - any level change on the accessible route
 - reserved seats and spots for people with reduced mobility (refer section 9, Figure 21)
- 11.6 TGSi tiles being used for the accessible route shall **not** be used elsewhere as a normal flooring material or just for aesthetic purpose to avoid confusion.

Note: Throughout the guidelines the colour of the warning tiles have been shown with red lines and the colour of the guiding blocks has been shown orange for ease in differentiating between the two types of TGSi. However, the actual colour of the tiles depends on the material availability (ideally yellow for both). It should be of a contrasting colour with respect to the flooring.

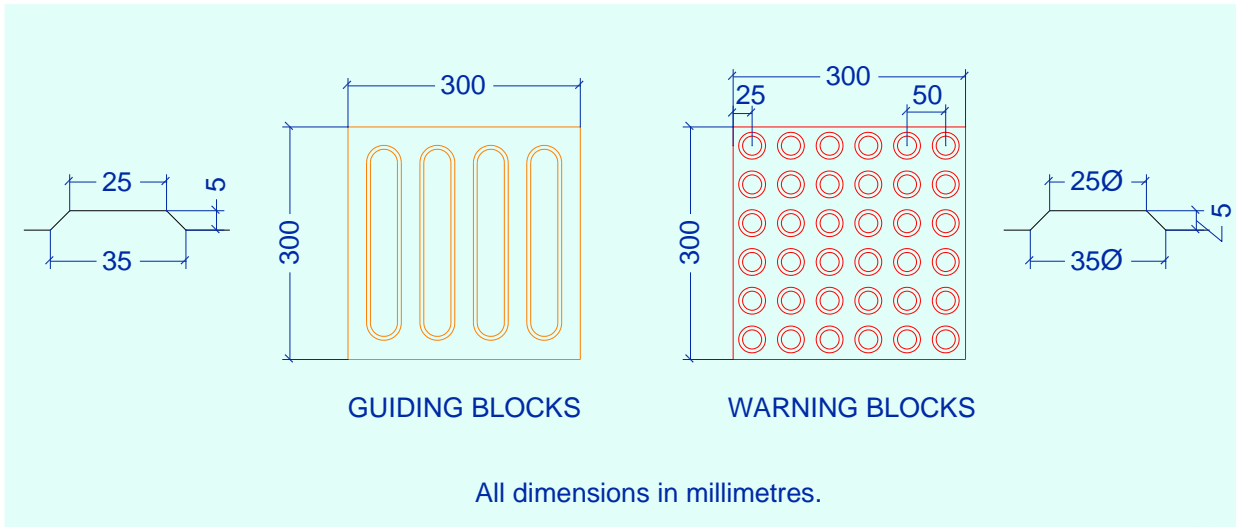

Figure 23: Tactile ground surface indicators (TGSi) (Source: NBC, 2016)

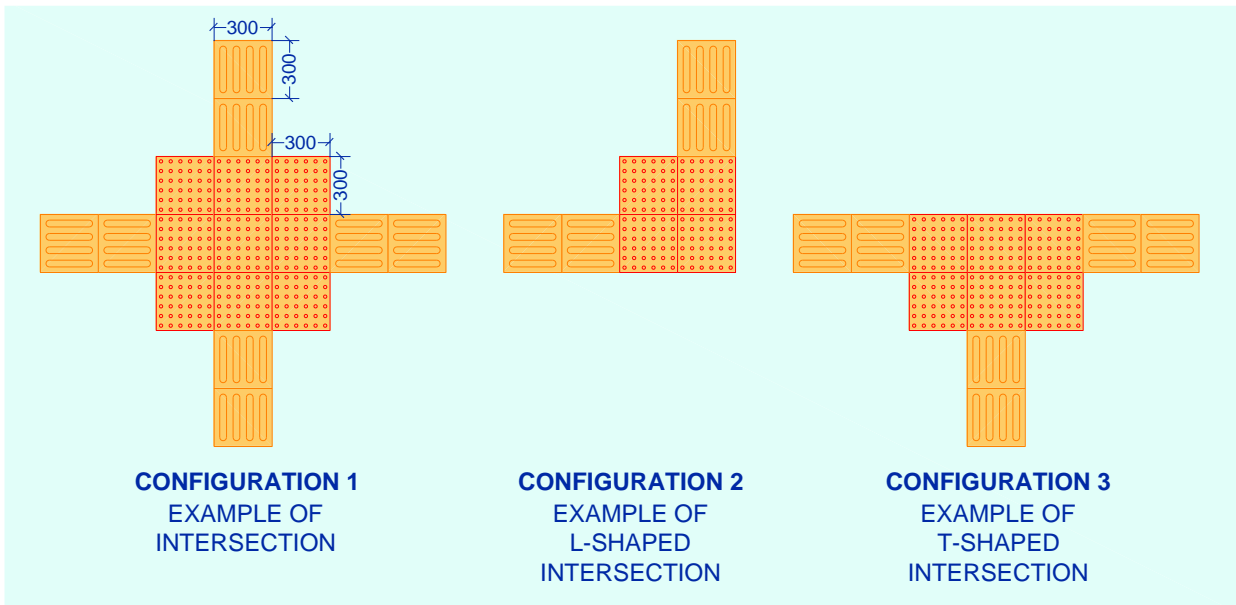

Figure 24: Arrangement of Tactile blocks for people with visual impairment

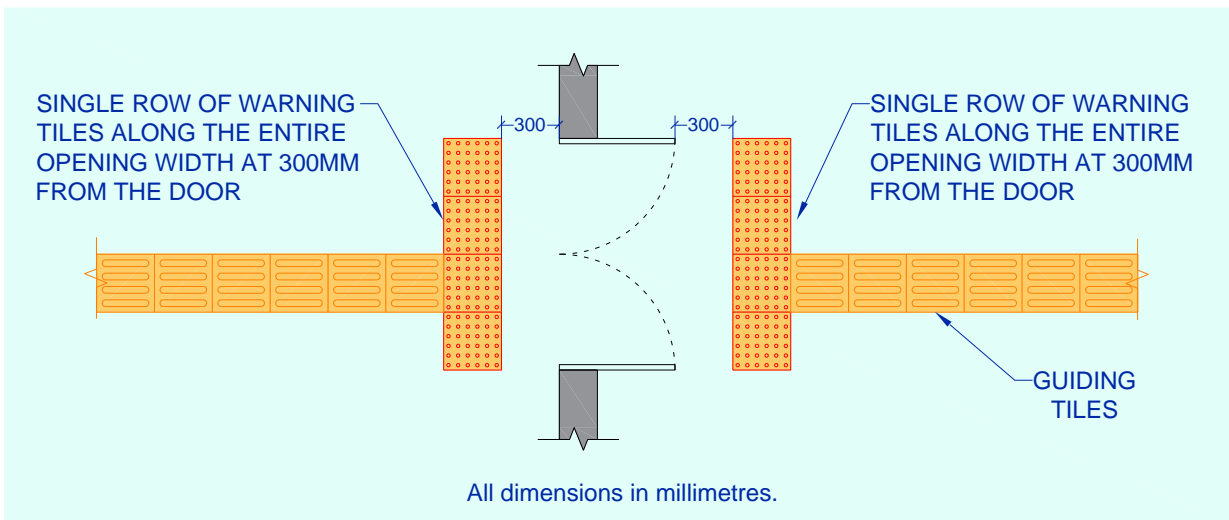

Figure 25: Placement of tactile tiles at a door

12. Accessible lift

- 12.1 The minimum size of the lift car should be 1900 mm x 1900 mm for all new establishments. In case where the space is not available, the lift car size shall be a minimum of 1500 mm x 1500 mm with minimum clear opening of 900mm to be provided. [6]
- 12.2 Accessible lift signage shall be provided outside the lifts as per section 19, Figure 54.
- 12.3 A sign indicating the number of the floor arrived shall be provided on each lift landing on the wall opposite to the lift in big fonts with good colour contrast. [10]
- 12.4 Call button shall be installed at a height of 800 mm to 1000 mm [6]
- 12.5 Braille buttons (in three languages – Hindi, English and the local language), emergency brake button and other operating mechanisms (control panel) should be provided at an accessible height of 900mm to 1200mm. [9] [6]
- 12.6 Grab bars should be placed on both the sides and rear of the lift at a height of 900mm from the floor level. [6]
- 12.7 Mirror should be placed at the rear of the lift. [9]
- 12.8 Accessible lift shall be connected to the accessible route. Warning tactile tiles to be placed 300mm in front of the lift opening as shown in Figure 26.
- 12.9 It is recommended to install a floor directory of the main facilities and services available on the lift landing, along with an accessible emergency egress route that clearly indicates the location of the nearest refuge area for persons with disabilities. [10]
- 12.10A non-contact sensor device shall be provided in the door opening to detect an entering or exiting passenger or an assistive device and prevent the risk of the passenger or assistive device from being hit by the leading door panel(s). The sensor device shall cover at least 2/3 of the door height measured from a distance of 25 mm above the door sill. Time of closing of an automatic door shall be more than 5 s and the closing speed shall not exceed 0.25 m/s. The door opening time should be adjustable to suit the conditions where the lift is installed. A mechanism to increase this time should be installed to be customized by a user with mobility impairments (for example by means of a button outside the car to call the lift to the floor for it to arrive with extended door opening time, and a button marked with a wheelchair symbol inside the car with the same purpose). Under normal operation the levelling accuracy of the lift car shall be ± 12 mm. [10]
- 12.11 Minimum Lighting level of 200 Lux should be maintained in the lift and minimum audio level for audio/video display should be 35 db.
- 12.12 Auditory Output should be given once a lift reaches a floor to help visually challenged users determine the current location of a lift.

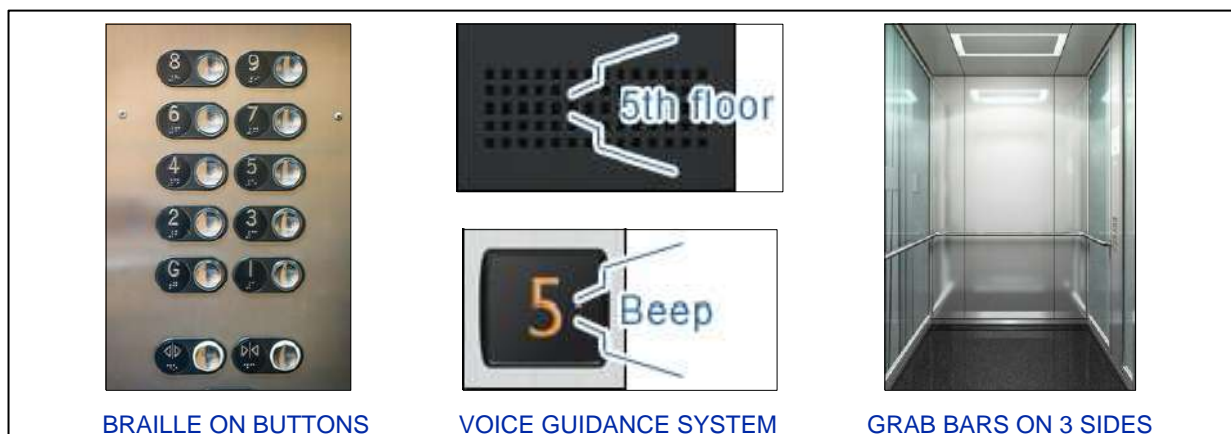

Image 8: Example of lift buttons and railing (Source: <http://www.melsa.com.sa/Elevators/NexWay>, <https://docplayer.net/docs-images/66/55531468/images/20-0.jpg>)

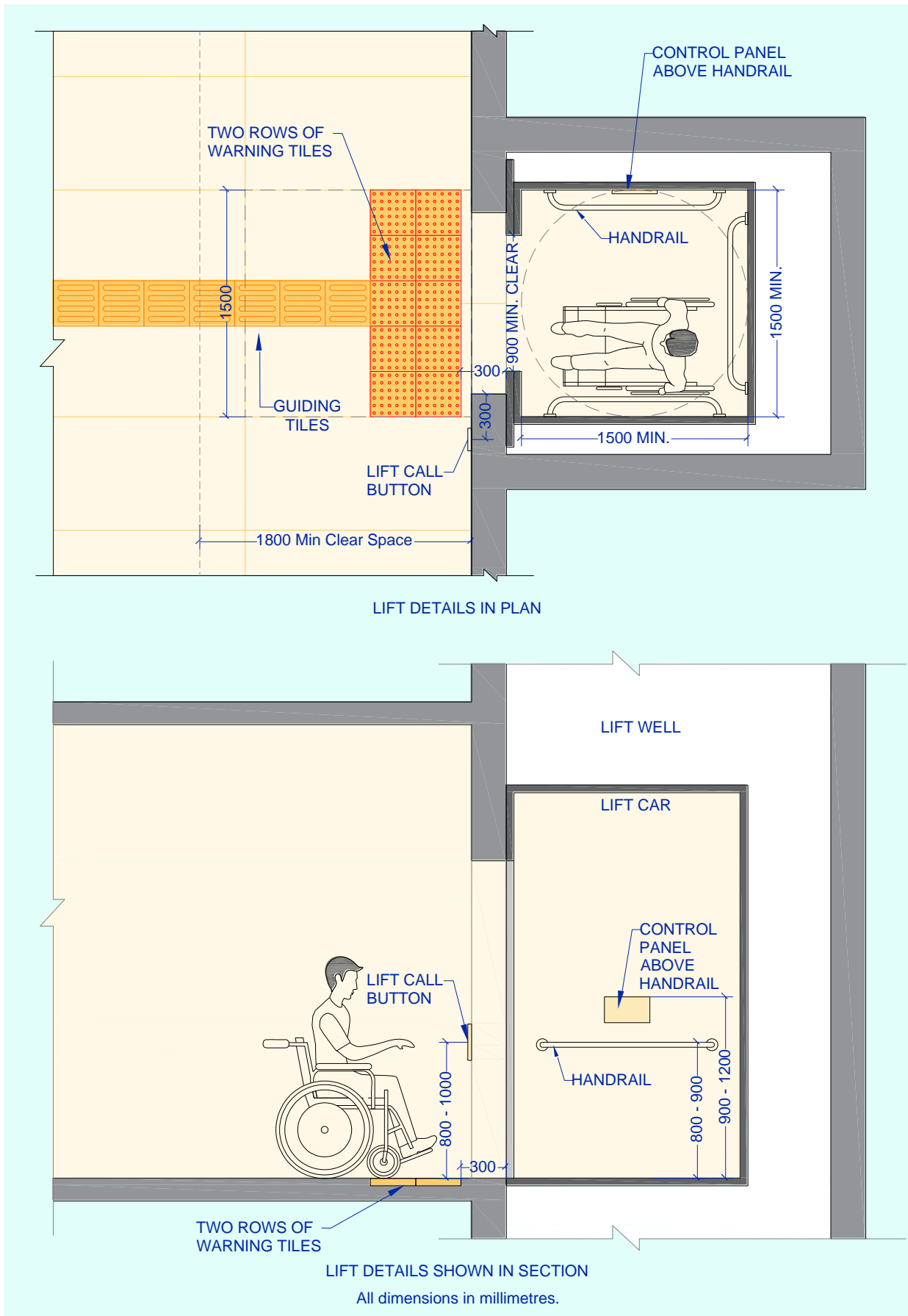

Figure 26: Lift details shown in plan and section

13. Ramps

13.1 Ramps help people with wheelchairs, old people, etc. to move from one level to another comfortably. Smaller changes in level should be treated as per slopes given in Table 4.

13.2 Ramps shall be provided along the city-side kerb as well as air-side kerb if there is a level difference between the approach road/ground and kerb. Two types of ramps can be given as per the level difference: Ramp with railings and Kerb ramp

13.3 Details of Ramp with railings (refer Figure 27 and Figure 28)

- a) Shall be provided along the accessible route on the city-side kerb and air-side kerb where the level difference is more than 200mm;
- b) Any of the three configurations of the ramp can be given as per site suitability: straight run, 90 degree turn and switch back or 180 degree turn.
- c) Shall have a two rows of tactile warning blocks placed at 300mm from the beginning and ending of each ramp. [10]
- d) Shall have a minimum width of 1200mm for straight run and wherever there is a mid-landing for turning, the minimum width of ramp shall be 1500mm; [6]
- e) Shall have continuous round handrails, on both sides and extended, rounded edges at the ends of 300mm as per section 15. The railing ends to have braille signage indicating the direction of movement as shown in Image 11 and Image 12 [10] [6]
- f) Shall have anti-skid flooring and self-illuminating strips on the edges.
- g) Shall have a level landing at the top and bottom of each run and also where the run changes direction [6]
- h) Signage showing the ramp to be provided as per section 19.
- i) Accessible ramp to be connected to the accessible route and warning tactile tiles to be placed 300mm before and after the sloped surface and at the mid-landings.
- j) Shall have a maximum gradient of 1:12. However, recommended slope of ramp is 1:15 to 1:20 for easy maneuver of wheelchair as per Table 3 if space is available. [9]

13.4 Details of Kerb Ramp (refer Figure 29 and Figure 30)

- a) To be provided where the vertical rise is less than 200 mm; [6]
- b) The kerb ramp shall not be less than 1200 mm in width. It shall have a clearance of at least 800 mm at the back of the kerb ramp on the footpath. [10]
- c) The gradient of a kerb ramp should not be steeper than 1:12; the flared sides should not be steeper than 1:10. [6]
- d) Shall have a slip-resistant surface; [6]
- e) Shall be designed to avoid water accumulation on the walking surface; [6]
- f) Does not require handrails;
- g) Shall not project out into the road surface; [6]
- h) Shall be located or protected to prevent obstruction by parked vehicles; and [6]
- i) Shall be free from any obstruction such as signposts, bollards, etc. [6]

Gradient of Ramp	Maximum length of horizontal run
1:12	6m
1:14	9m
1:15	11m
1:20	15m
Not Gentler than 1:25	18m

Table 3: Gradient and length of ramps

***Exception - fixed link bridge/ Fixed finger/ Aerobridge/ Passenger Boarding Bridge**

Changes in Vertical Rise (MM)	Gradient not steeper than
less than 6	edge treatment may not be required
6 to 15	1:2
16 to 50	1:5
51 to 200	1:10
Exceeding 200	1:12

Table 4: Changes in levels

***Exception - fixed link bridge/ Fixed finger/ Aerobridge/ Passenger Boarding Bridge)**

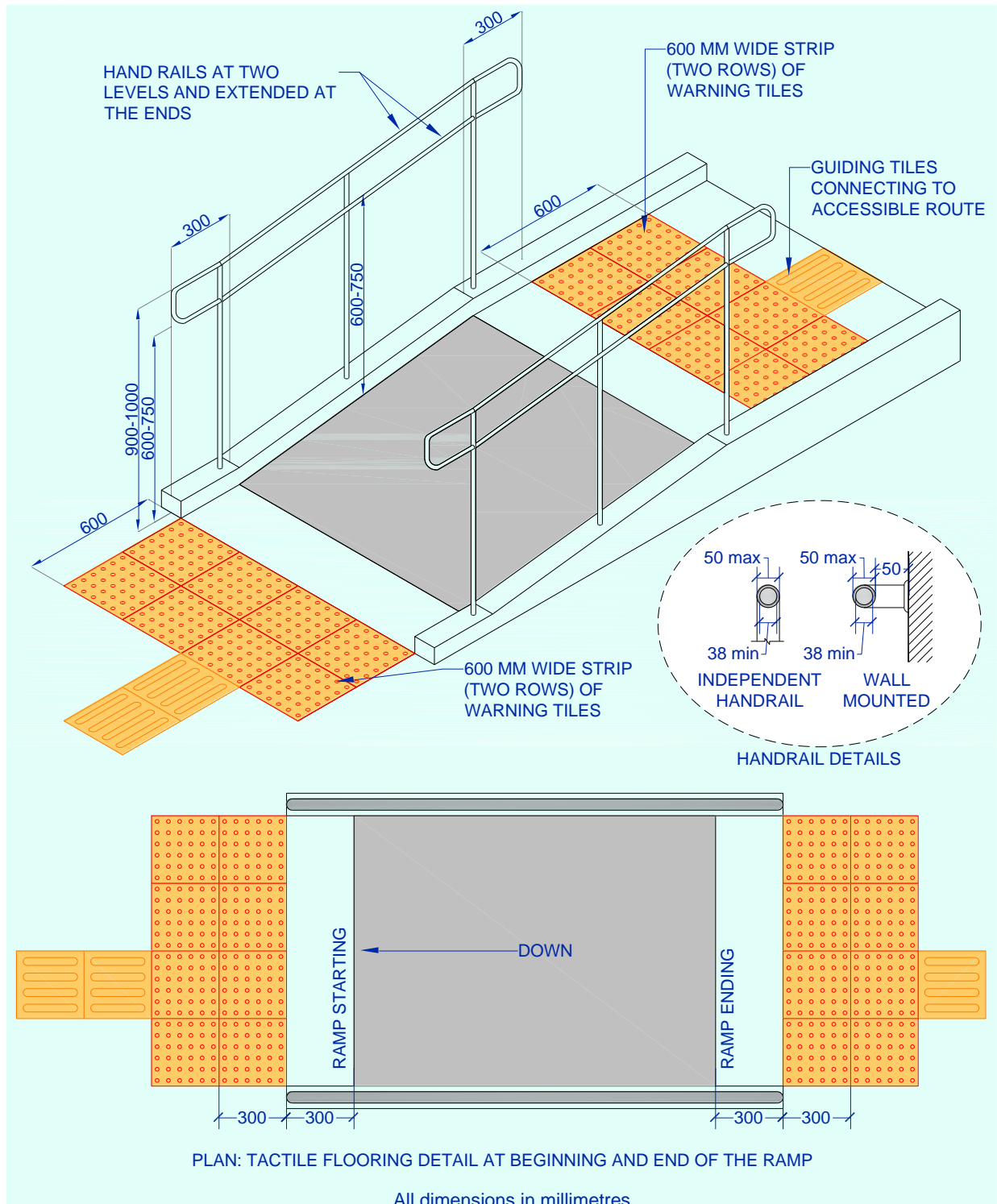

Figure 27: Handrails and tactile flooring for ramp with railing

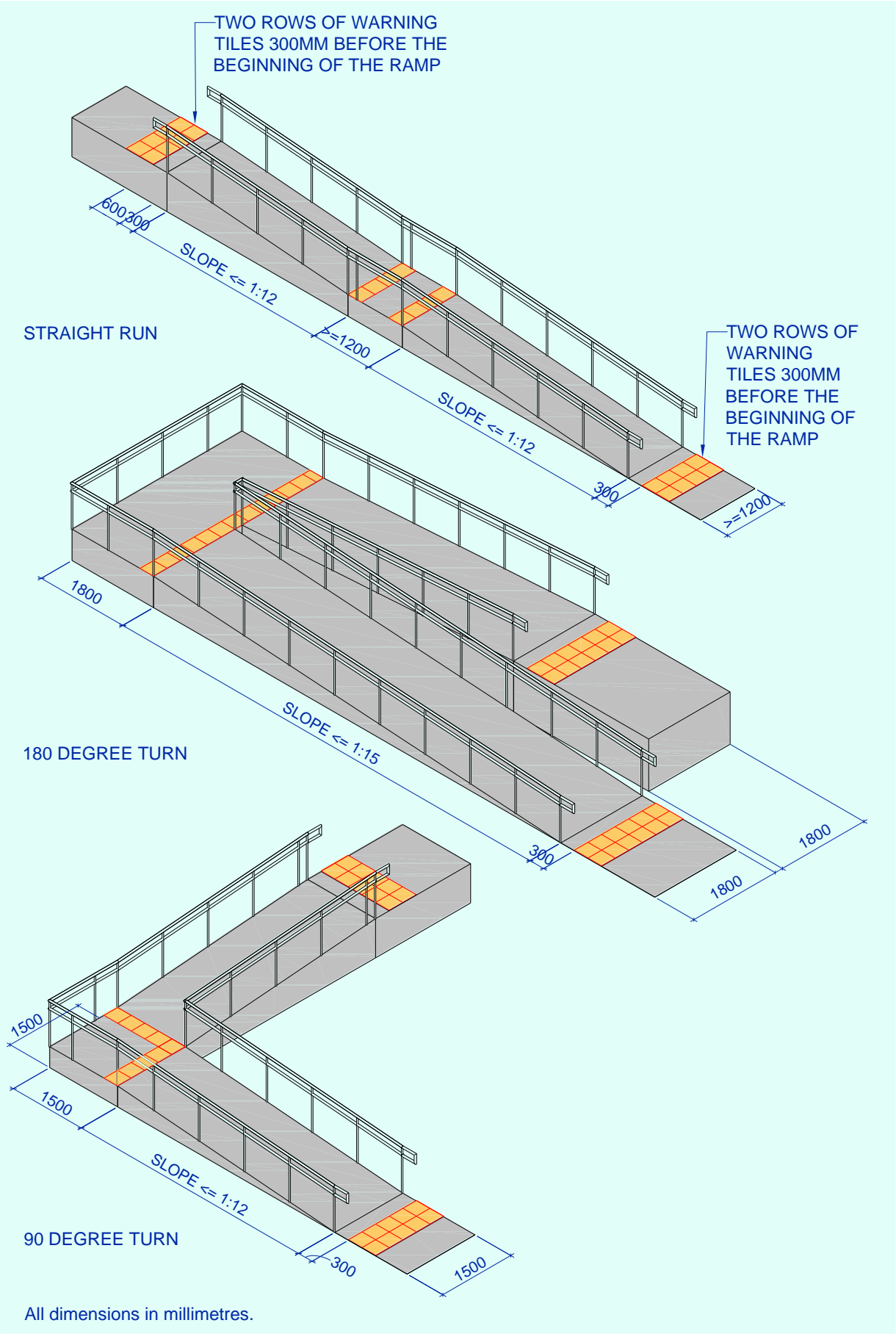
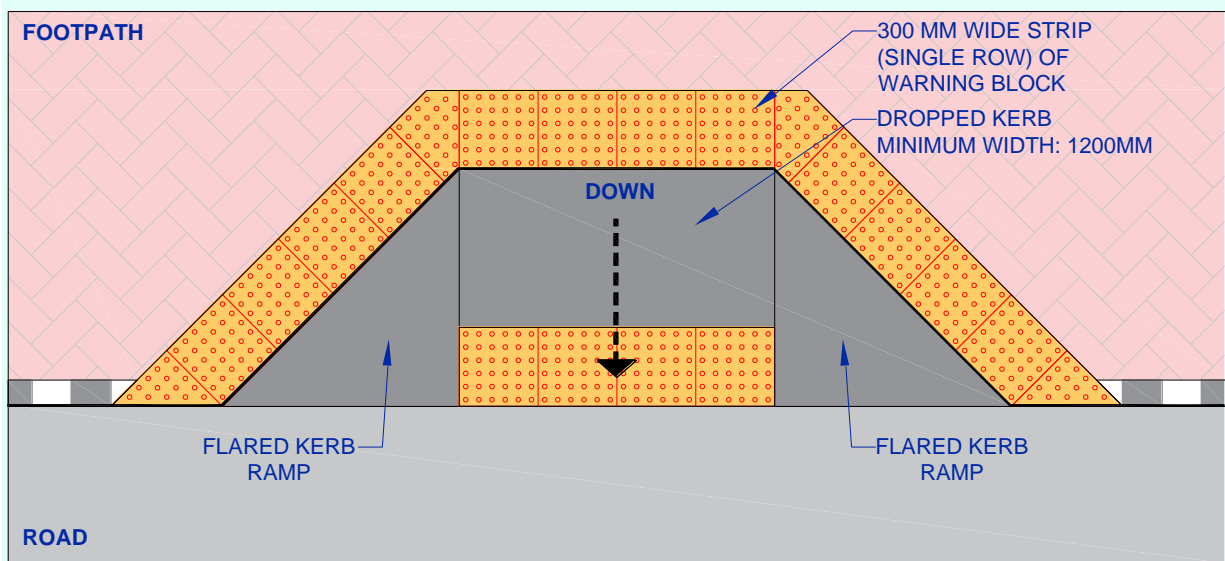
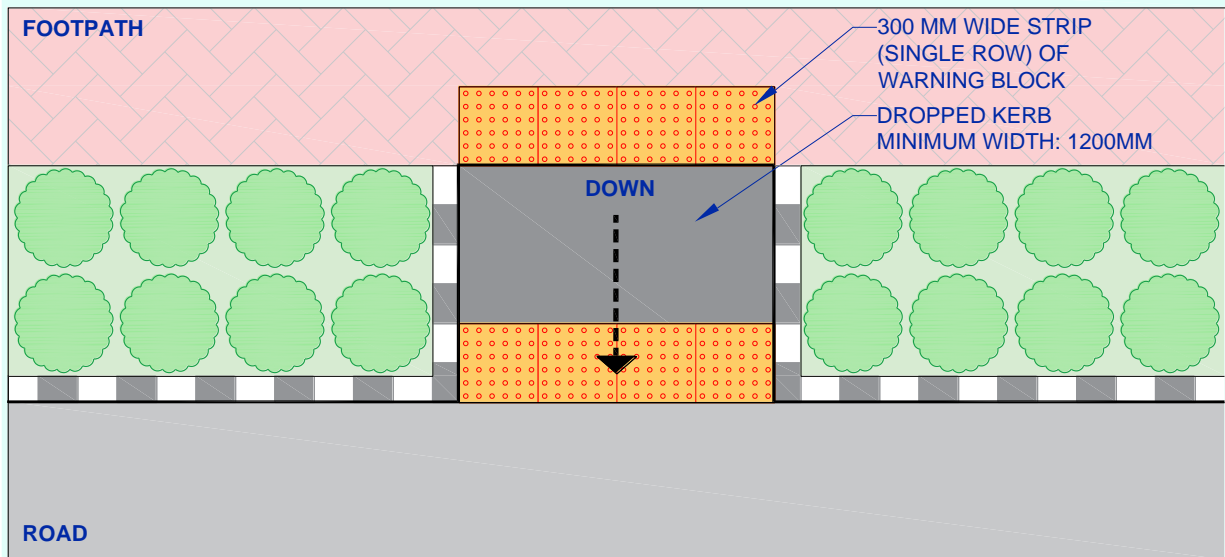

Figure 28: Examples of different types of ramps with railings



A. KERB RAMP WITH FLARED SIDES



B. KERB RAMP WITH RETURNED KERB

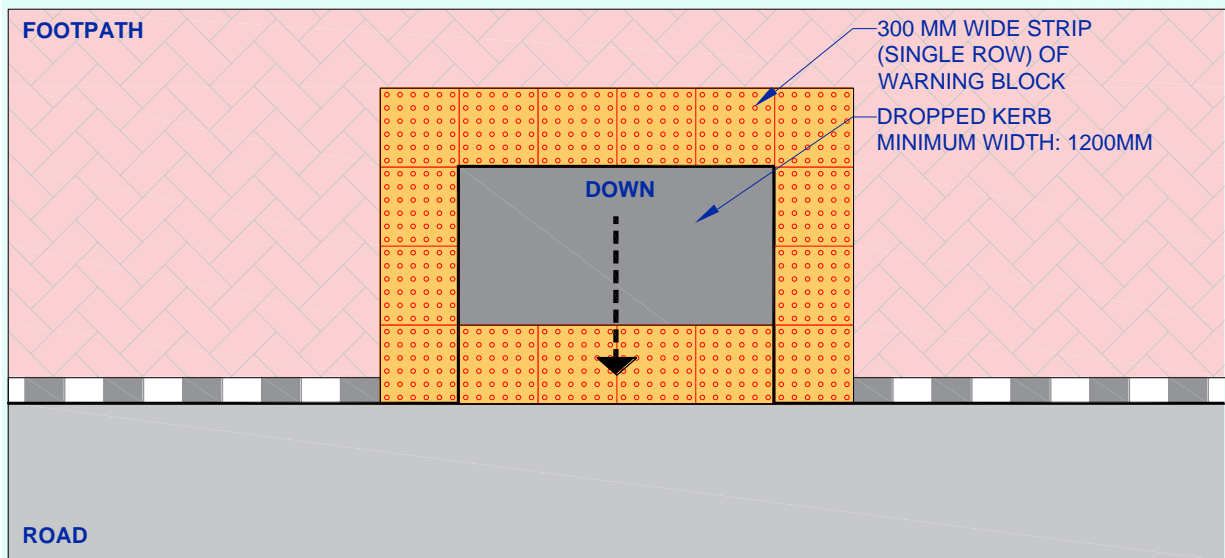

C. KERB RAMP WITH CONTINUOUS KERB

Figure 29: Types of kerb ramps shown in plan

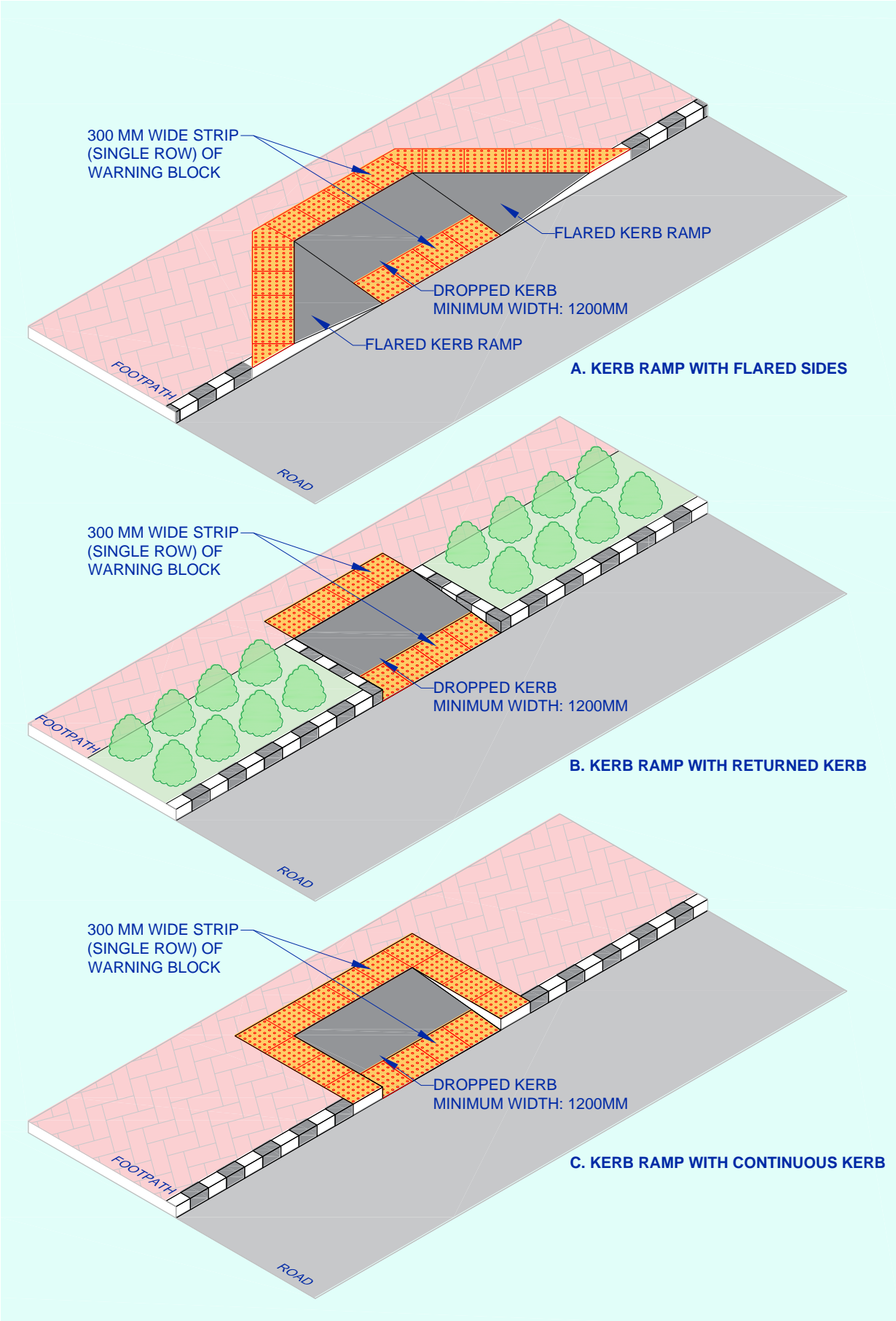

Figure 30: Types of kerb ramp shown in view

14. Steps and Staircase

- 14.1 Regular steps of tread (width) not less than 300mm and rise (height) not more than 150mm shall be provided. [7] [6]
- 14.2 Staircase to have minimum 1500mm clear width (excluding tread mounted balustrade). [6]
- 14.3 Staircase landing shall have minimum depth of 1200mm. [6] [10]
- 14.4 Colour contrasting 50mm wide grip strips (glow in the dark, retro reflective kinds) to be provided 50mm after the nosing at the edge of the tread. [6]
- 14.5 Warning blocks should be installed 300 mm before the beginning and 300 mm after the end of each flight of steps [6] [9]
- 14.6 Continuous round handrails, on both sides, at a height of 750 mm and 900mm with rounded ends at the ends as per section 15 [6]
- 14.7 Handrails shall extend horizontally not less than 300mm beyond the first and last nosing of every flight of steps and terminate into a closed end which shall turn down or return fully to end post or wall face and shall not project into a route of travel. [6]
- 14.8 Where steps or stairs are in an accessible route, complementary ramps, lifts or escalators shall be provided [7]

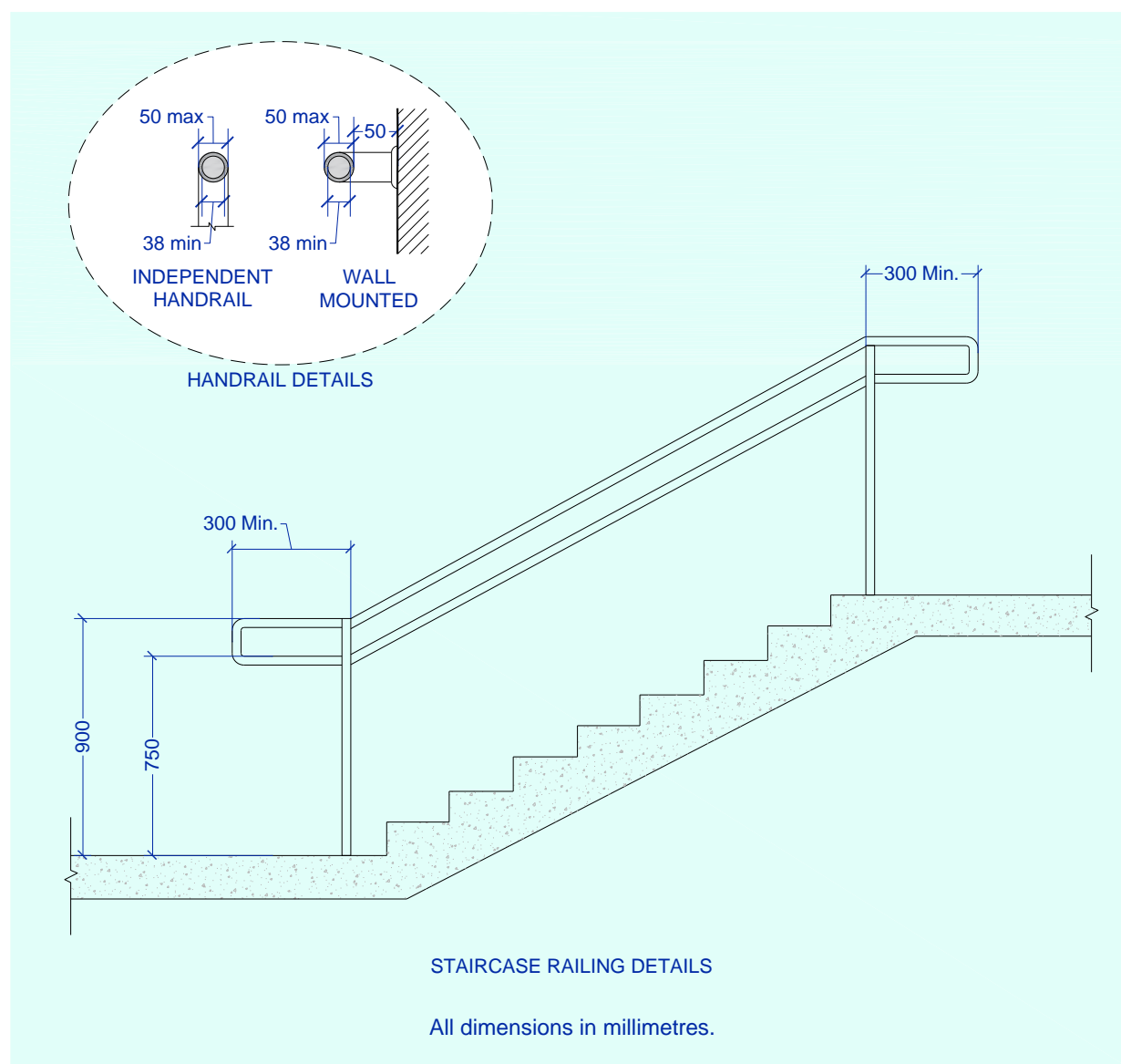

Figure 31: Handrails for steps and stairs (Source: NBC, 2016)

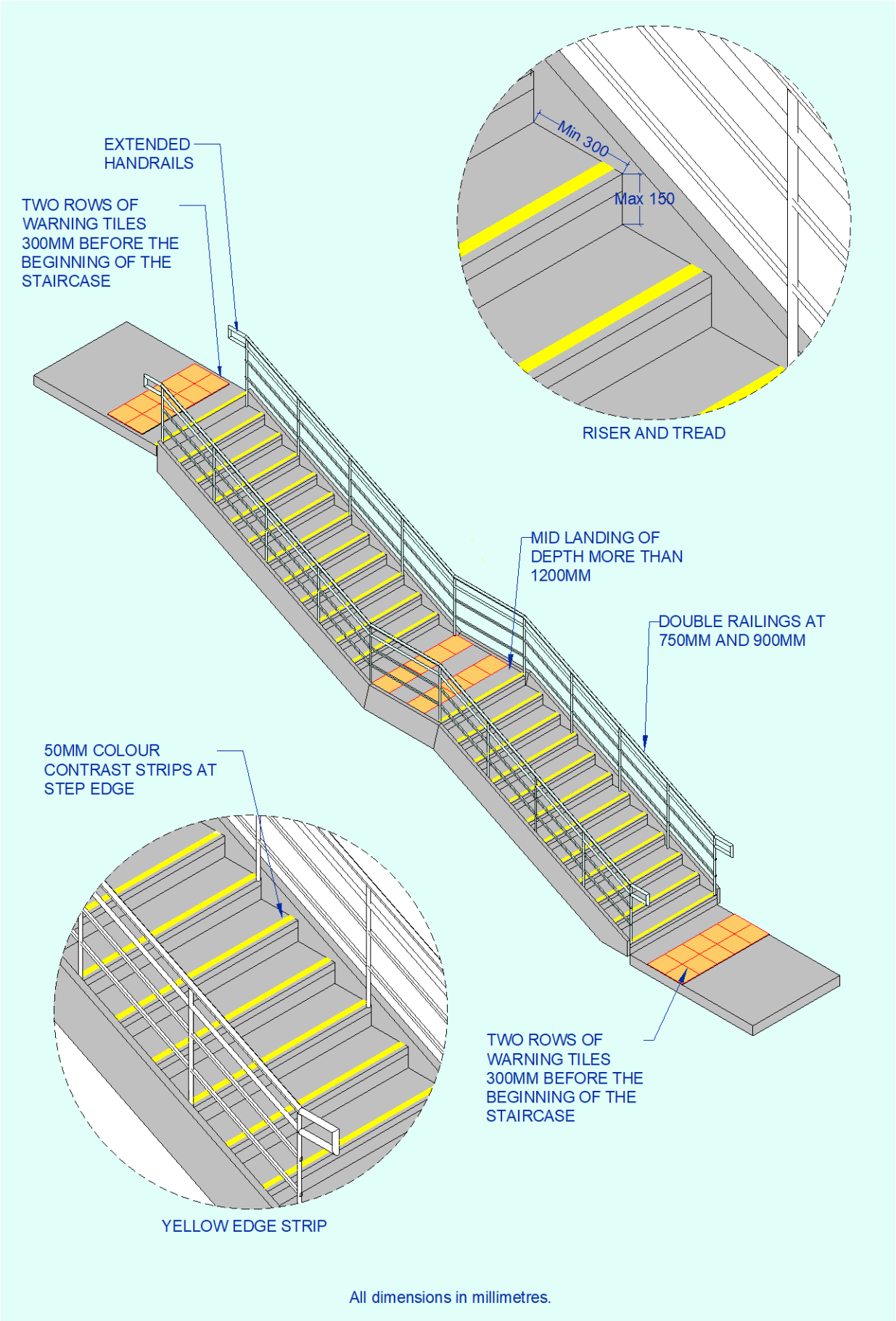

Figure 32: Staircase detail



Image 9: Example of tactile flooring provided at the beginning of the staircase

(Source: <https://cdn.mainichi.jp/vol1/2021/07/16/20210716p2a00m0op015000p/8.jpg?1>)

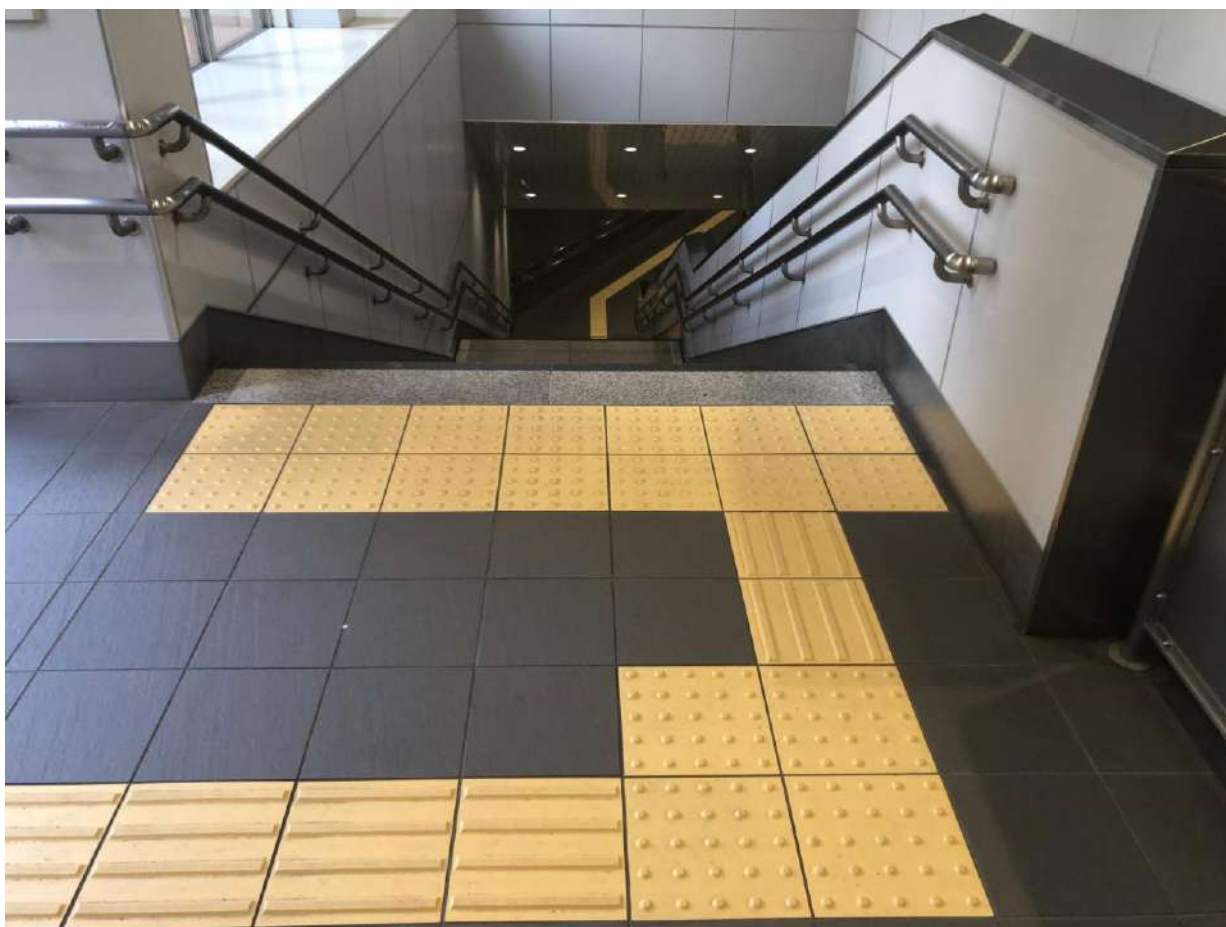

Image 10: Example of tactile flooring provided at the beginning of the staircase and handrails at two levels (Source: https://cdn-japantimes.com/wp-content/uploads/2020/08/np_file_30691.jpeg)

15. Handrails

- 15.1 Continuous round handrails, on both sides, at a height of 650-750 mm and 900-1000mm with rounded edges at the ends [6] [8]
- 15.2 Handrails shall be made from materials which provide good grip such as timber, nylon or powder coating, matt finish or metal finishes. [8]
- 15.3 Braille indicator to be provided at both ends of the handrails (indicating the direction of movement) [9]
- 15.4 Handrails should be circular in section with a diameter of 38-50mm [7] [6] [8]
- 15.5 The fastenings and the materials shall be able to withstand a minimum point load, both vertical and horizontal of 1.7 kN. [10]
- 15.6 At least 50mm clear of the surface to which they are attached and should be supported on brackets which do not obstruct continuous hand contact with the handrail. [7] [6] [8]
- 15.7 Handrails shall extend horizontally not less than 300mm beyond the first and last nosing of every flight of steps and terminate into a closed end which shall turn down or return fully to end post or wall face and shall not project into a route of travel. [6] [8]

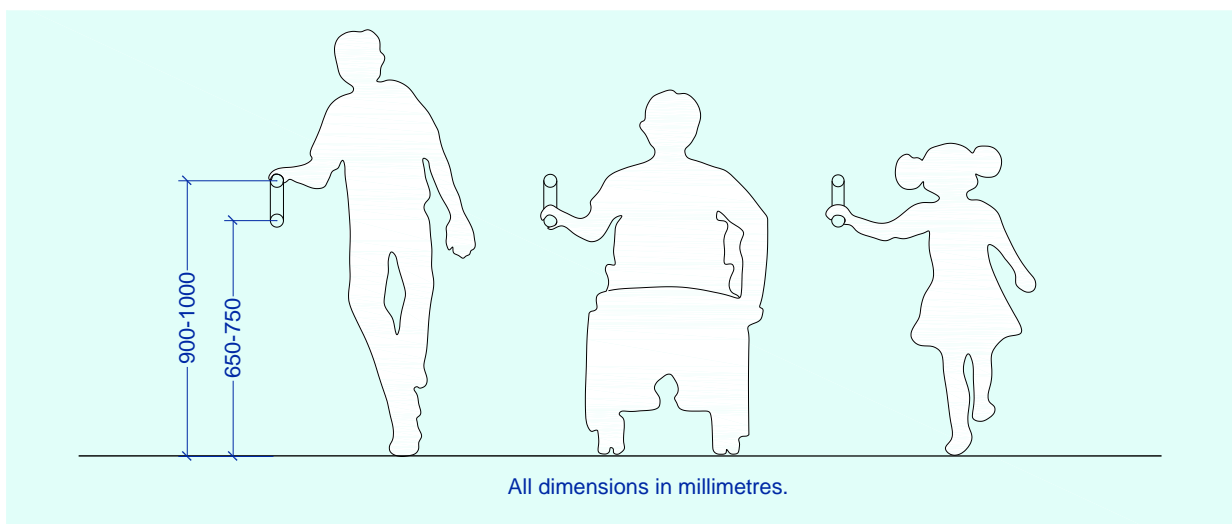

Figure 33: Handrails at two levels to help children, old people and people with short stature

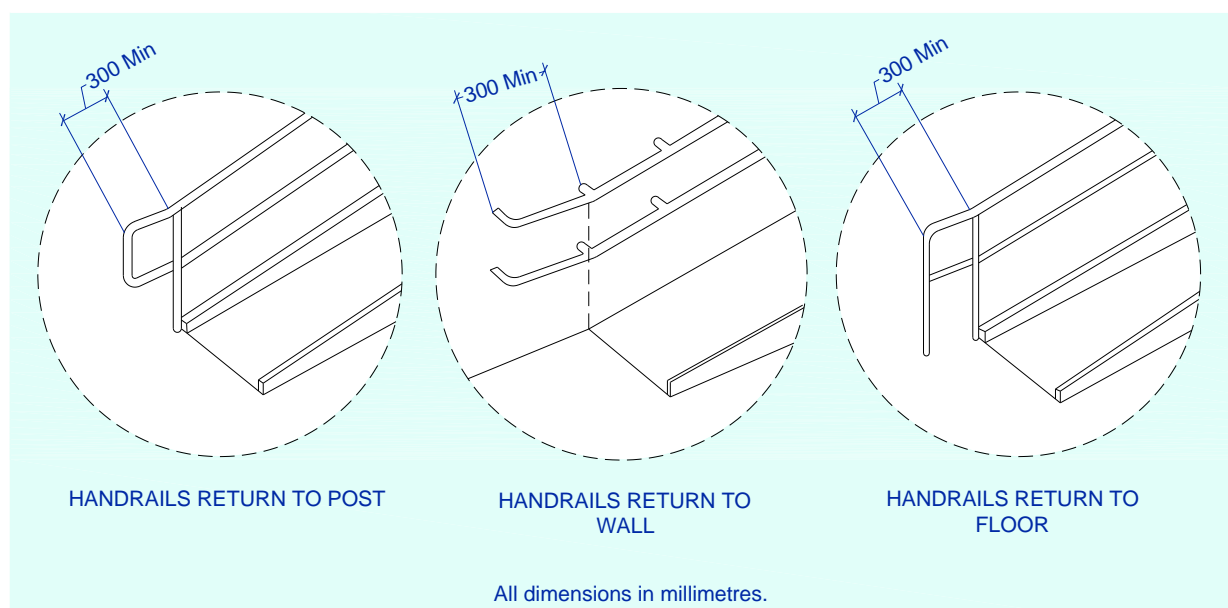

Figure 34: Typical handrail extensions (Source: NBC, 2016)



Image 11: Braille indicators at end of the handrails (Source: https://static.wixstatic.com/media/2f4db7_eab6b34aba264b0fab6143b2c80454fb~mv2_d_3264_2448_s_4_2.jpg)



Image 12: Tactile indicators at end of the handrails
(Source: <https://shop.signbox.co.uk/30/117/pasamano-braille-wayfinding>)

16. Accessible Toilets

- 16.1 Two types of toilets can be provided:
- If a new construction is being done, then type A toilet shall to be given.
 - If an existing toilet is to be converted into an accessible toilet, then it shall at least have the minimum dimensions of type B toilet.
 - Type A toilet is always preferred over Type B toilet. Wherever possible, type A toilet shall be provided. Only in case of retrofitting where there isn't enough space for type A toilet, should the type B toilet be considered.
- 16.2 Type A toilet (lateral transfer from both sides) requirements:
- Minimum dimensions – 2200mm x 2300mm as shown in Figure 35 [10]
 - Clear manoeuvring spaces that provides a wheelchair turning radius of 1800 mm in front of the water-closet and washbasin [10]
- 16.3 Type B toilet (lateral transfer from only one side) requirements:
- Minimum dimensions – 1700mm x 2200mm as shown in Figure 36 [10]
 - Clear manoeuvring spaces that provides a wheelchair turning radius of 1500 mm in front of the water-closet and washbasin [10]
- 16.4 General requirements for type A and type B toilet -
- Outward-opening double-swing/sliding type door, minimum 900mm wide and shall not require a force of more than 22N to operate. Automatic doors can also be used. [10] [6]
 - Door handles – D-Type / Lever type (not knobs). Door locks should be designed such that people without limbs can also open them [9]
 - Difference in floor level should be less than or equal to a tile drop at the toilet entrance door (no Choukhat) [9]
 - WC top height – 450mm to 480mm. The minimum distance of the edge of the WC seat to the adjacent wall shall be 250 mm. In case of Type A toilet, the distance from the edge of the WC seat to the adjacent wall shall be minimum 900 mm on both sides to allow ease of transfer. [10]
 - Washbasin top height – 750 mm to 850mm. The space under the washbasin shall be unobstructed with a knee clearance centred on the washbasin between 680 mm and 700 mm high, and 200 mm deep. In addition, a toe clearance of at least 300 mm high shall be provided [10]
 - Grab bars/ door handles/all fittings/accessories/operable items should be of contrasting colour wherever possible and should be placed at approachable height of 300mm to 1000mm from the floor, be easy to operate and have adequate strength (250 kgs). [9]
 - Grab bars - On the sides where a lateral transfer is possible, a foldable grab bar (drop-down support bar) shall be provided at a height of 200 mm to 300 mm above the water-closet. Where a wall is beside the toilet, a horizontal grab bar shall be provided at a height of 200 mm to 300 mm above the water-closet, and a vertical grab bar shall exceed from the horizontal grab bar to a height of 1500-1700 mm above floor level. Alternatively, one L-shape grab bar, 600 mm long horizontal and 700-900 mm long vertical shall be mounted on the side wall closest to the water-closet (Figure 37) [10]
 - Anti – skid flooring [9]
 - Height of latch-at base (foot operable/non-protruding) and mid height (750-800mm) [9]
 - Long/ lever handles of taps [9]
 - Emergency buttons with pull-chain switch to be provided in the toilet, one on three walls as shown in Figure 35 and Figure 36. Emergency bell alert to be given to housekeeping. Training to be given to them to handle PRMs carefully. [9]
 - Signage (Figure 53) to be provided above and on the side of the door (at 1200mm). [9]

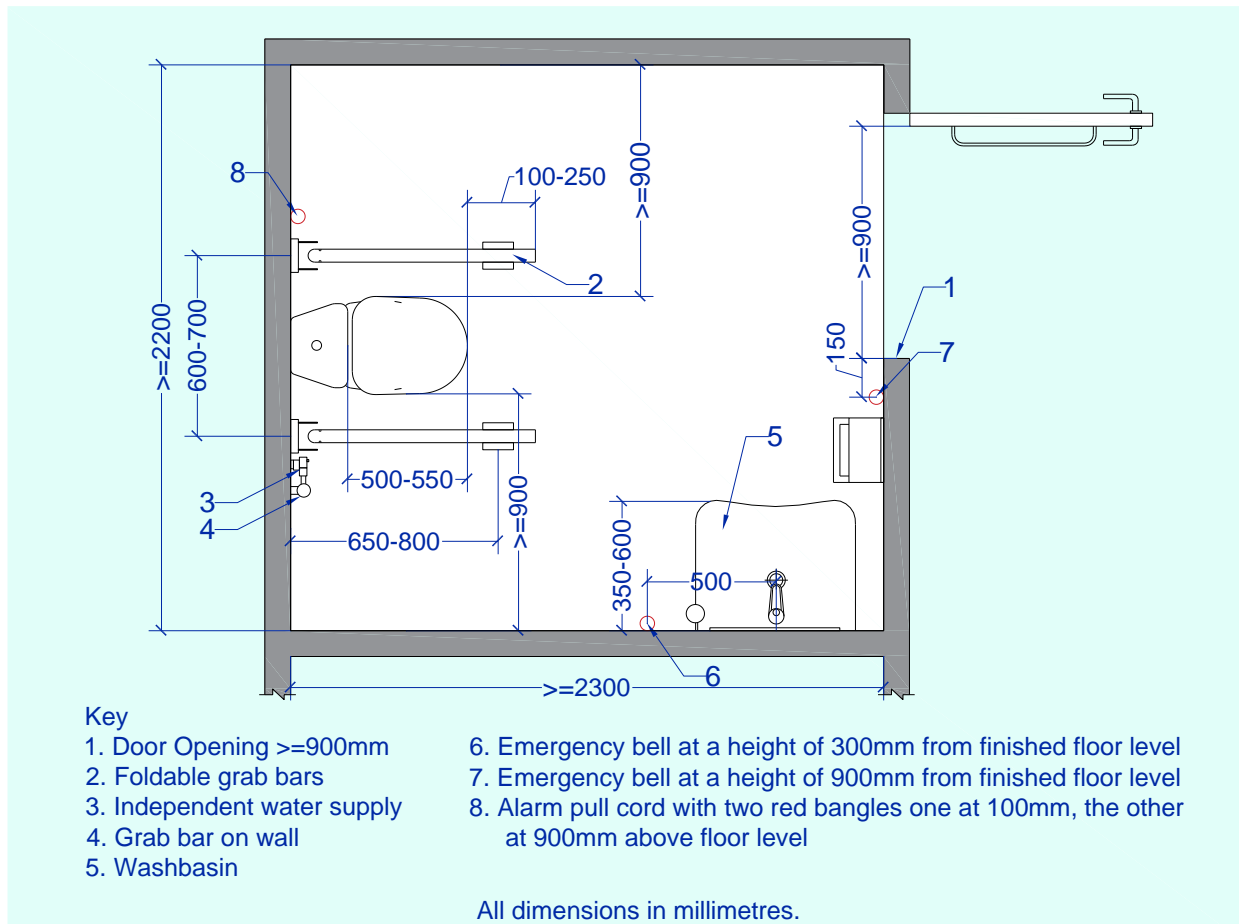

Figure 35: Example of Type A Toilet Room - Lateral Transfer from both sides

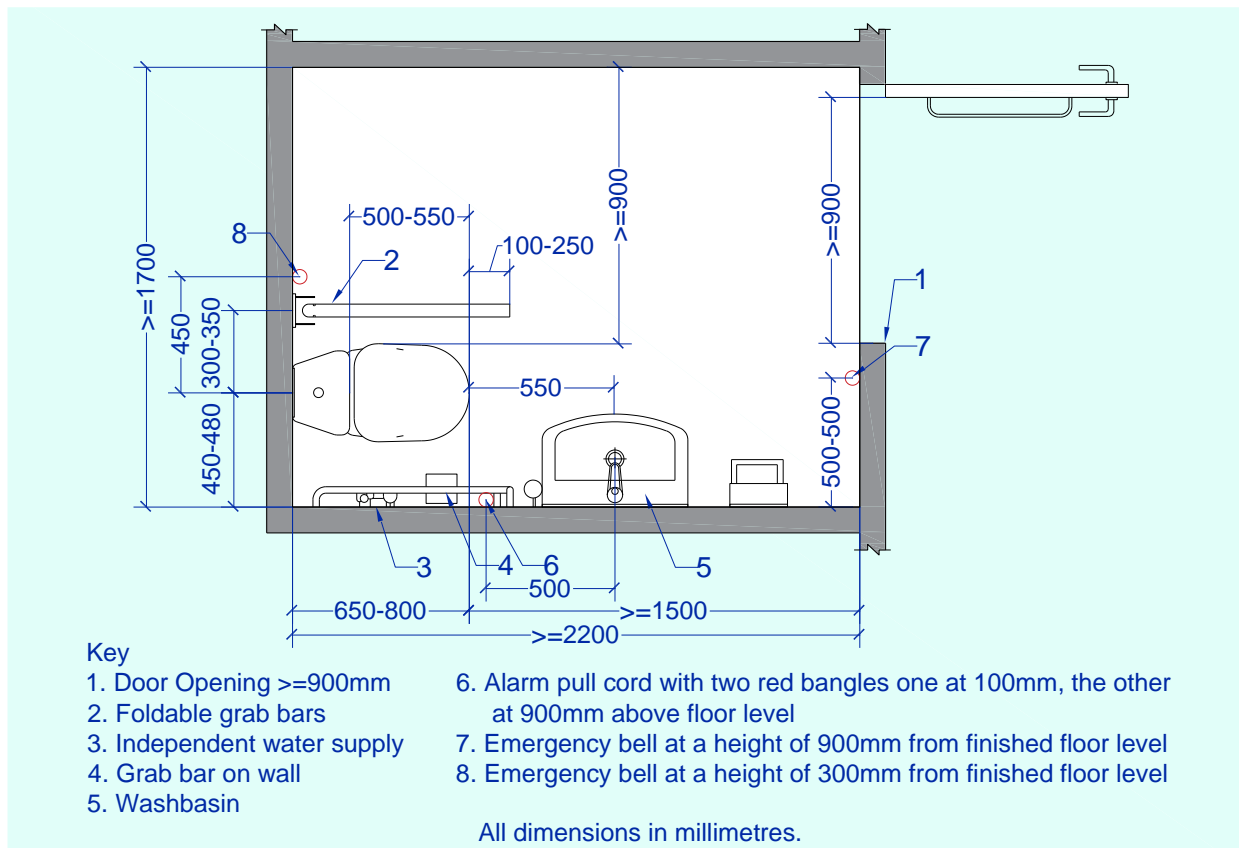

Figure 36: Example of Type B corner toilet - Lateral transfer from one side only

16.5 Accessible toilets of type A or type B should be provided in lounges. It includes the lounges maintained by private concessioners as well.

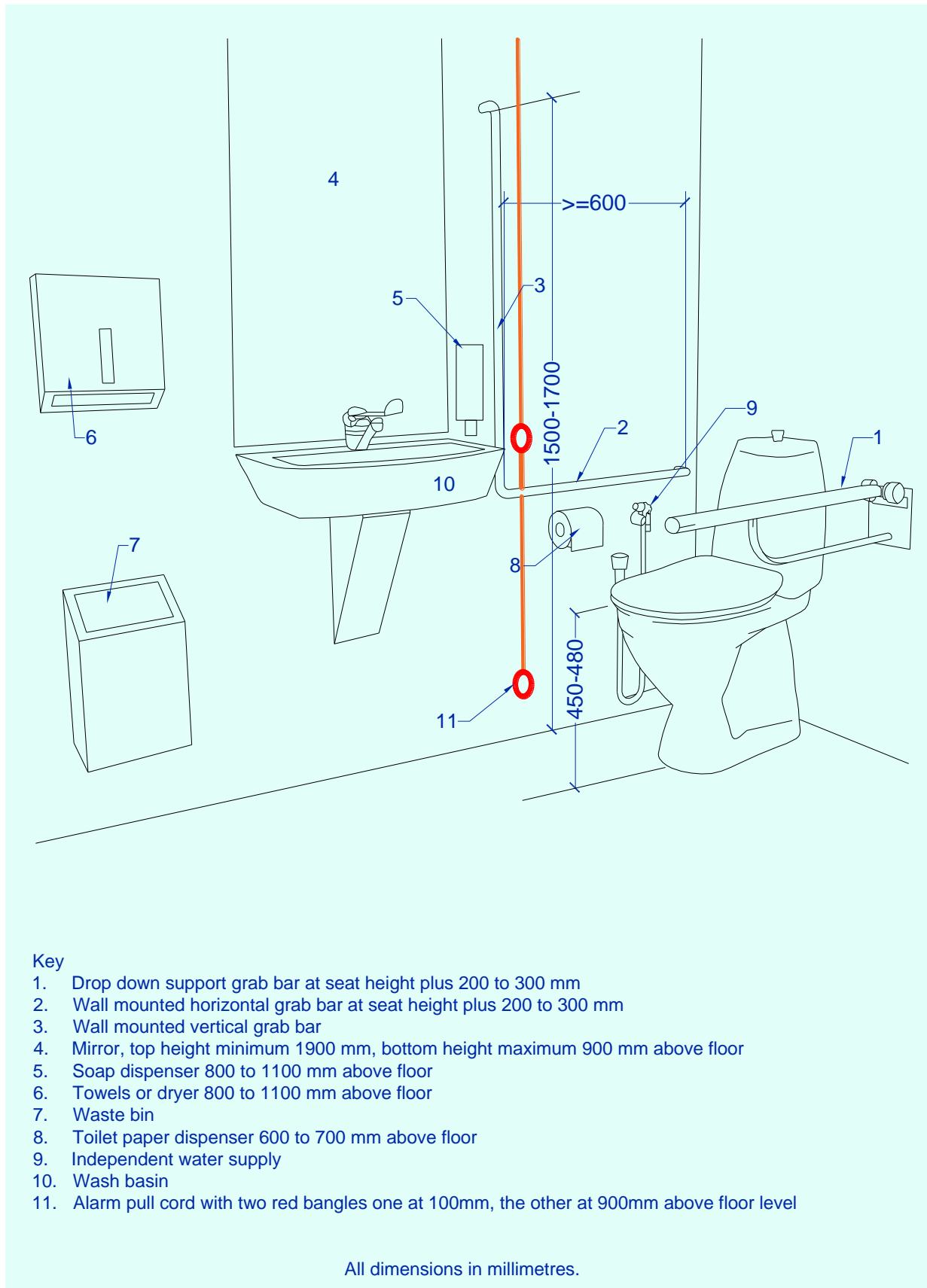

Figure 37: Positioning accessories in Type B toilet

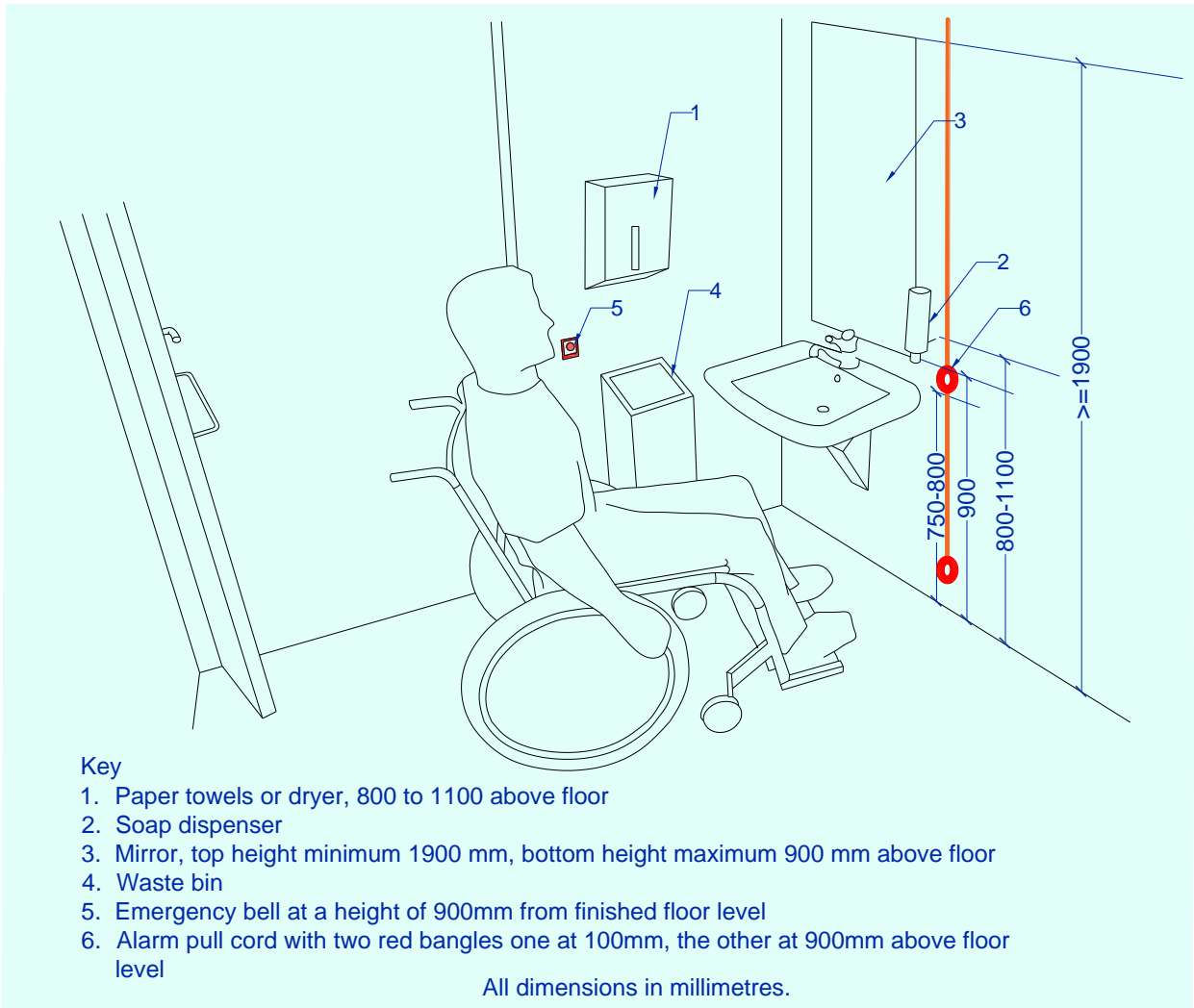

Figure 38: Placement of washbasin and mirror with distances of sanitary appliances

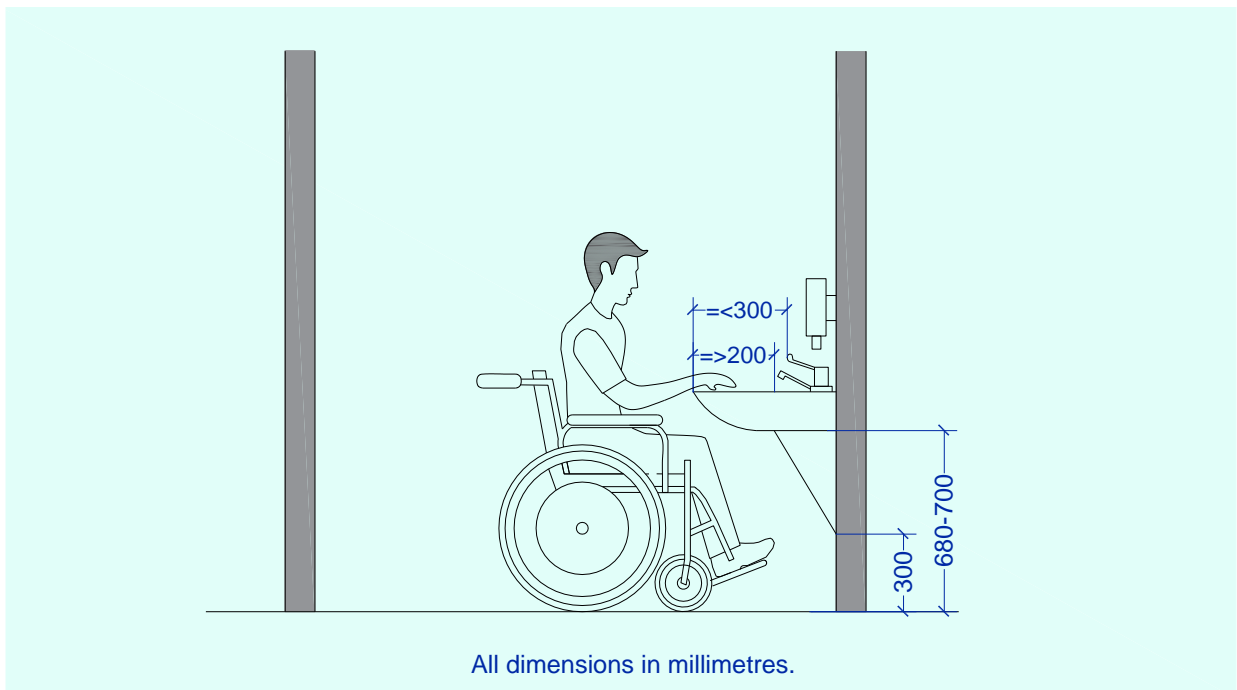

Figure 39: Section showing washbasin with toe and knee clearance (Source: NBC, 2016)



Image 13: Example of lever type tap, foldable grab bars, etc. in accessible toilet type A (Source: <https://www.ableamsterdam.com/wp-content/uploads/2019/06/accessible-toilets-2-1024x662.jpg>)



Image 14: Example of type B toilet with emergency alarm pull chord at two levels (Source: <https://www.disabilityaids.co.nz/wp-content/uploads/WC-Suites.jpg>)

16.6 In the **Common Toilet Block** the following elements need to be given:

- a) One wall mounted diaper changing station in male as well as female toilet block
- b) One Washbasin with following features shall be provided:
 - i) It shall provide a minimum clear floor space of 900 mm wide by 1200 mm deep, of which a maximum of 480 mm in depth may be under the washbasin. [6]
 - ii) It shall be mounted such that the minimum distance between the centreline of the fixture and the sidewall is 460 mm; and the top edge of the wash basin is between 750 mm and 850 mm from the floor. The front edge of the washbasin shall be located within 350 mm to 600 mm from the wall [6]
 - iii) The space under the washbasin shall be unobstructed with a knee clearance centred on the washbasin between 680 mm and 700 mm high, and 200 mm deep. In addition, a toe clearance of at least 300 mm high shall be provided. [6]
 - iv) Automatic or lever type faucets/taps should be provided [6]
- c) One Indian style toilet cubical with following features shall be provided:
 - i) L-shaped grab bars (600mm horizontal length and 700mm vertical length) on both side walls/partitions. The positioning of accessories such as hand towel, soap, waste bin, etc. should not hamper the use of the grab bar. [6]
- d) At least one urinal mounted at a height of about 400 mm from the finished floor level should be provided in the male toilet for young children.
- e) One accessible urinal with following features shall be provided:
 - i) Grab bars; installed on each side and in the front of the urinal to support ambulant persons with disabilities (for example, crutch users). The front bar is to provide chest support; the sidebars are for the user to hold on to while standing. [6]
 - ii) Stall-type or wall-hung, with an elongated rim at a maximum of 430 mm above the finish floor. [6]
 - iii) A clear floor space 760 mm by 1200 mm should be provided in front of urinals to allow forward approach. Urinal shields or screens (that do not extend beyond the front edge of the urinal rim) may be provided with 735 mm clearance between them
 - iv) Flush controls should be located not more than 1200 mm from the floor. [6]

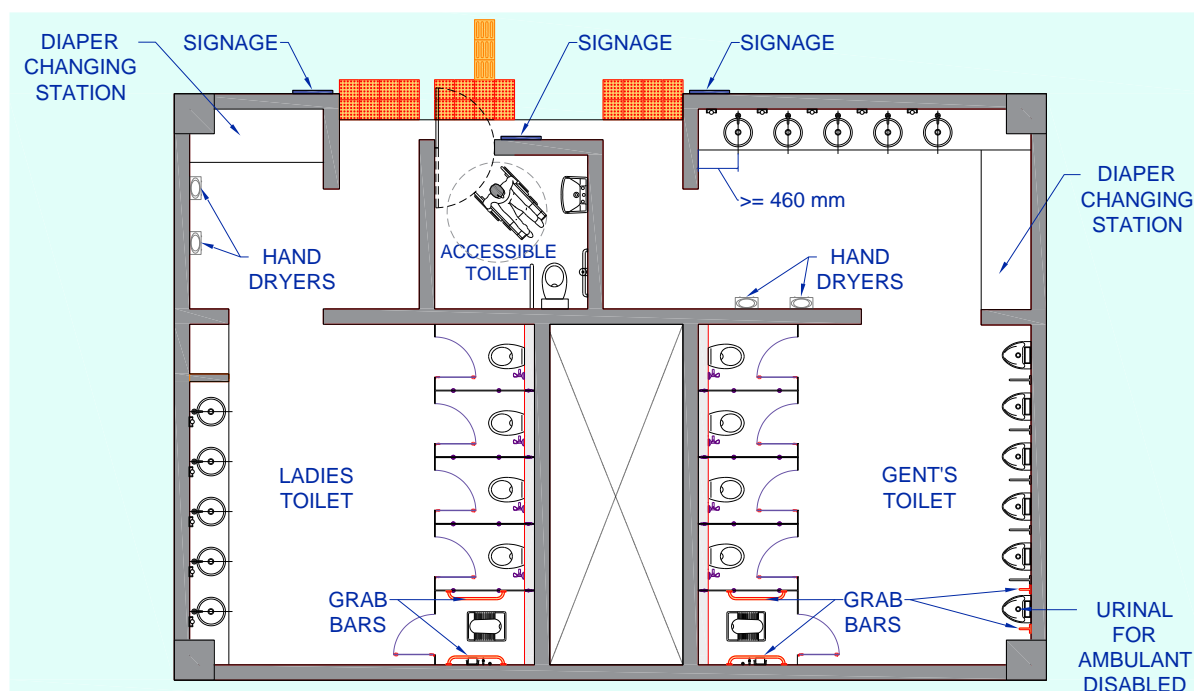

Figure 40: Typical toilet block plan

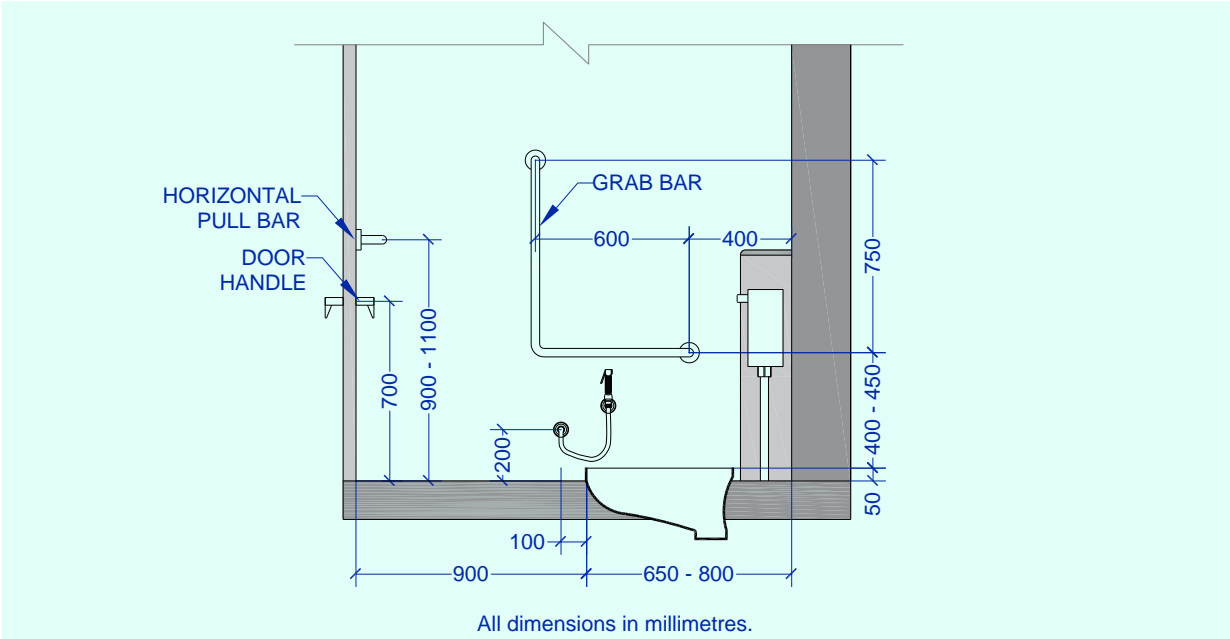

Figure 41: Section showing grab bar placement in Indian toilet cubical



Image 15: Examples of accessible urinal and low height urinal for children
(Source: <https://www.alsco.co.nz/wp-content/uploads/2020/03/alsco-nz-water-saving-urinals.jpg>, <https://www.beehiveplumbing.com/wp-content/uploads/2017/04/commercial-urinal-services.jpg>)

17. Accessible Drinking Water Facility

- 17.1 The provision of two drinking facilities at different heights is very convenient for standing adults, people in wheelchairs and children. Where only one counter is provided, it shall be at a height of 700 mm above floor level [10]
- 17.2 Spout heights shall be between 800-900 mm [10]
- 17.3 Water units shall have a clear space of 900mm X 1200mm in front of them [9] [10]
- 17.4 The front edge of the unit shall extend 400-450 mm from the wall. It shall have a clear knee space between the bottom of the apron/ equipment and floor or ground of at least 900 mm wide, 200 mm deep extending from the front edge of the equipment and 700 mm high. [10]
- 17.5 It shall have a toe space not less than 900 mm wide, 300 mm high, extending from the back wall to a maximum of 150 mm. [10]
- 17.6 Lever type tap systems/sensor-based taps (at two levels) with easy to use systems to be used. Fountain type taps can also be given.
- 17.7 Non-skid surface with proper drainage shall be created.
- 17.8 Single row of warning tiles shall be given in front of the drinking water facility and it should be connected to the accessible route.
- 17.9 Drainage near the area shall be covered to prevent falls.

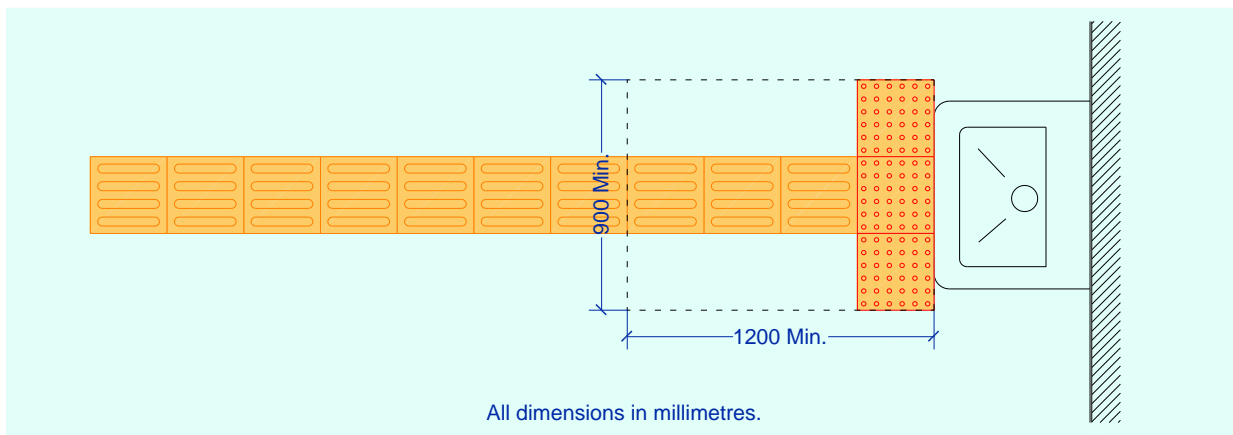

Figure 42: Clear floor space for freestanding or built-in drinking water unit not having clear space under the unit

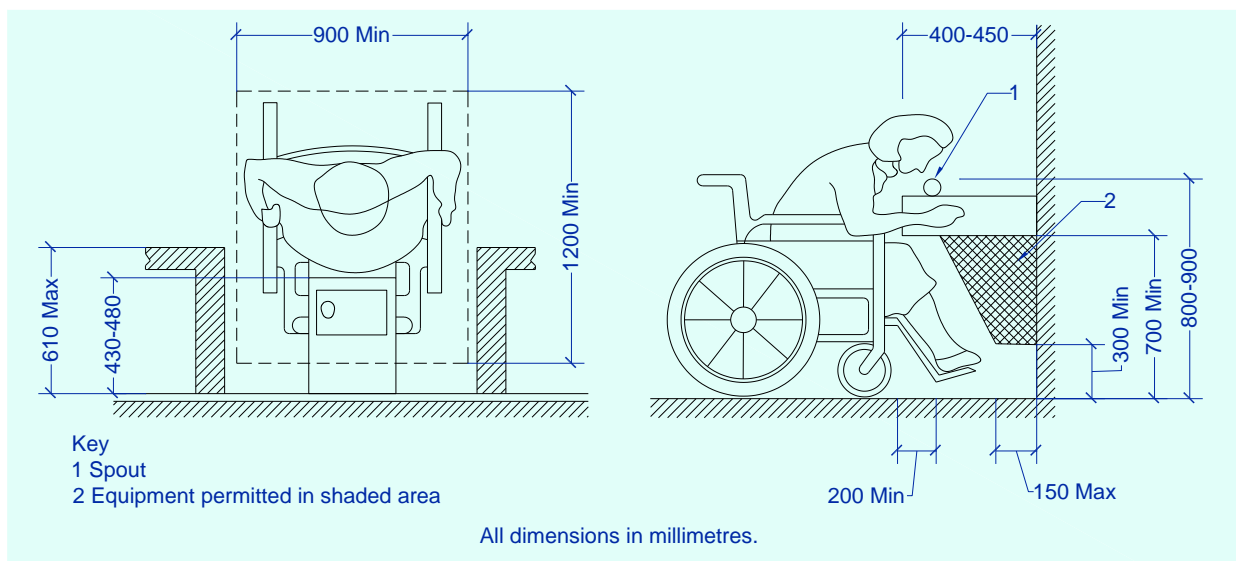

Figure 43: Wall-mounted drinking water unit details



Image 16: Example of Drinking water facility with taps on two levels installed in Madurai Airport

18. Service Animal/Pet Relief Area (SARA)

- 18.1 SARA should be connected to the accessible route of each terminal for pets and service animals. One relief area may serve two or more terminals if travel to and from it meets reasonable transit times as defined in paragraph 18.2. [12]
- 18.2 Transit time - No more than 15 minutes from any gate, based on a walking pace of 200ft/min. Includes expected time spent using transportation vehicles and waiting time for an escort, wheelchair, or elevators [12]
- 18.3 Size and shape - May be of any shape, but should be designed to accommodate a person using a wheelchair handling a service animal on a 1.8 m (six-foot) leash. In busier locations, a relief area may be sized to accommodate more than one service animal at one time. [12]
- 18.4 Surfaces. A relief area shall have at least two different surfaces:
- a) One hard and located immediately inside the entrance to allow wheelchair access. This surface should be delineated in a manner to indicate the portion intended to be traversed by people, and the portion intended for animal relief.
 - b) The other appropriate softer surface, such as gravel or mulch for outdoor areas, and artificial turf specially designed as an animal relief surface, treated to inhibit the spread of disease, for indoor (and outdoor) areas. [12]
- 18.5 Fencing or another suitable barrier, with an accessible gate/entrance, adequate to contain service animals should be provided. [12]
- 18.6 Plumbing:
- a) The SARA shall include a sink with a faucet for hand washing. Water must be potable as a drinking water supply for animals.
 - b) The surface shall be constructed with adequate drainage to facilitate regular cleaning.
 - c) A separate water supply shall be included for use in cleaning the surface. [12]
- 18.7 Location:
- a) Where it is not feasible to establish an outdoor relief area within the sterile area, the relief area will have to be constructed indoors. It can be located near an existing block so that plumbing services are simplified.
 - b) SARA must not be co-located with a designated smoking area. [12]
- 18.8 Weather protection:
- a) Outdoor SARA shall include weather protection from sun and precipitation.
 - b) If the SARA is close to operating aircraft, protection from jet blast and prop wash must be provided. [12]
- 18.9 Scent - The sense of smell is much more acute in animals than in humans. This can be a help or a hindrance in encouraging service animals to use a relief area. Pheromone-scented surfaces or devices can be beneficial, while disinfecting chemicals with strong odors can be detrimental. [12]
- 18.10 Accessories - The SARA, at a minimum, shall include:
- a) A three-dimensional device (e.g. rock or fake fire hydrant) to encourage urination by male dogs to be placed in one of the corners on the soft surface.
 - b) Animal waste bags.
 - c) A waste receptacle. [12]
- 18.11 Signage to be provided above the entrance, beside the door as shown in Figure 55

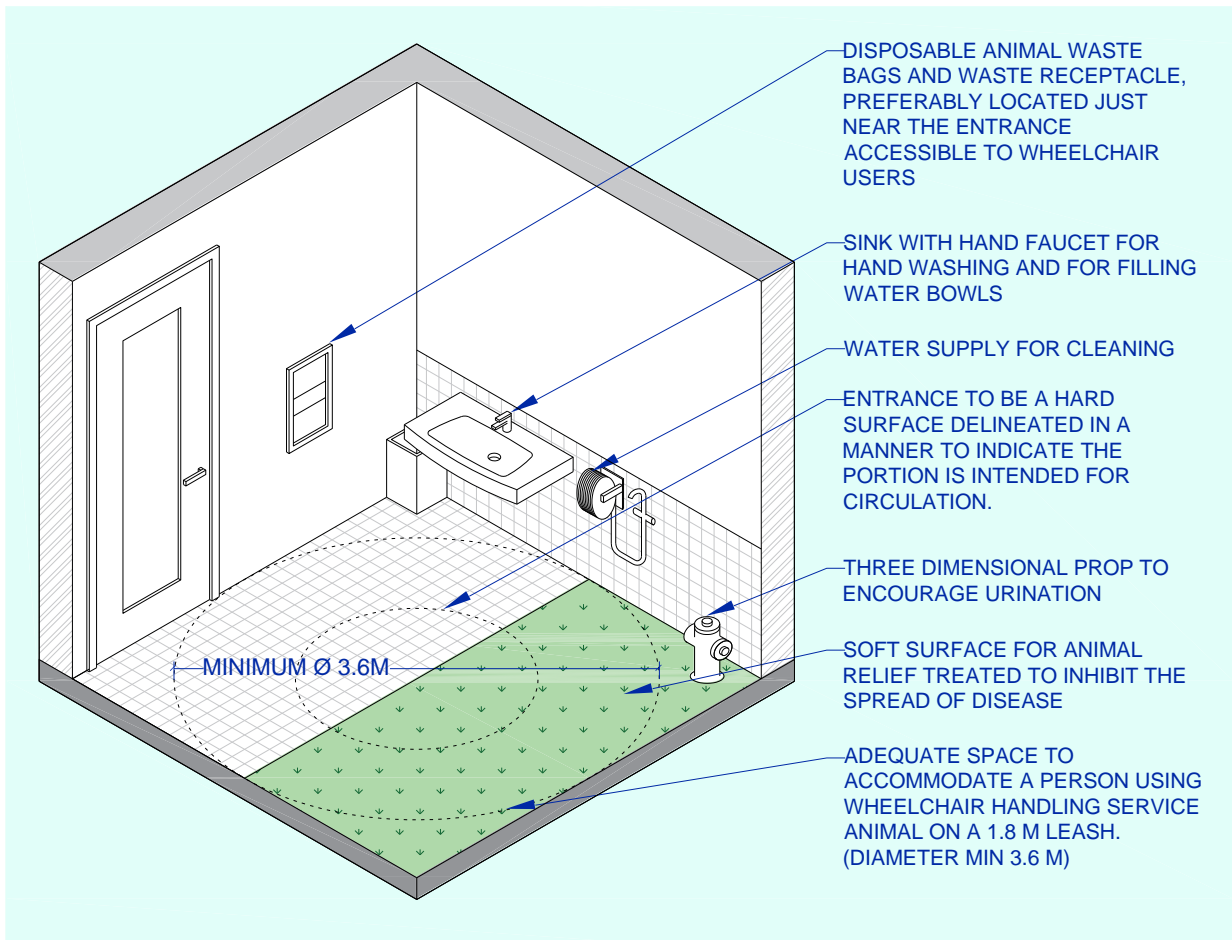

Figure 44: Details of Service Animal/Pet Relief Area



Image 17: SARA at Hartfield Jackson Atlanta Airport (Source: <https://thecakeboutiquect.com/>)



Image 18: SARA at St. Louis Lambert International Airport
(Source: https://petfriendlytravel.com/pft_airports/st-louis-lambert-international-airport-stl-pet-relief-areas/)

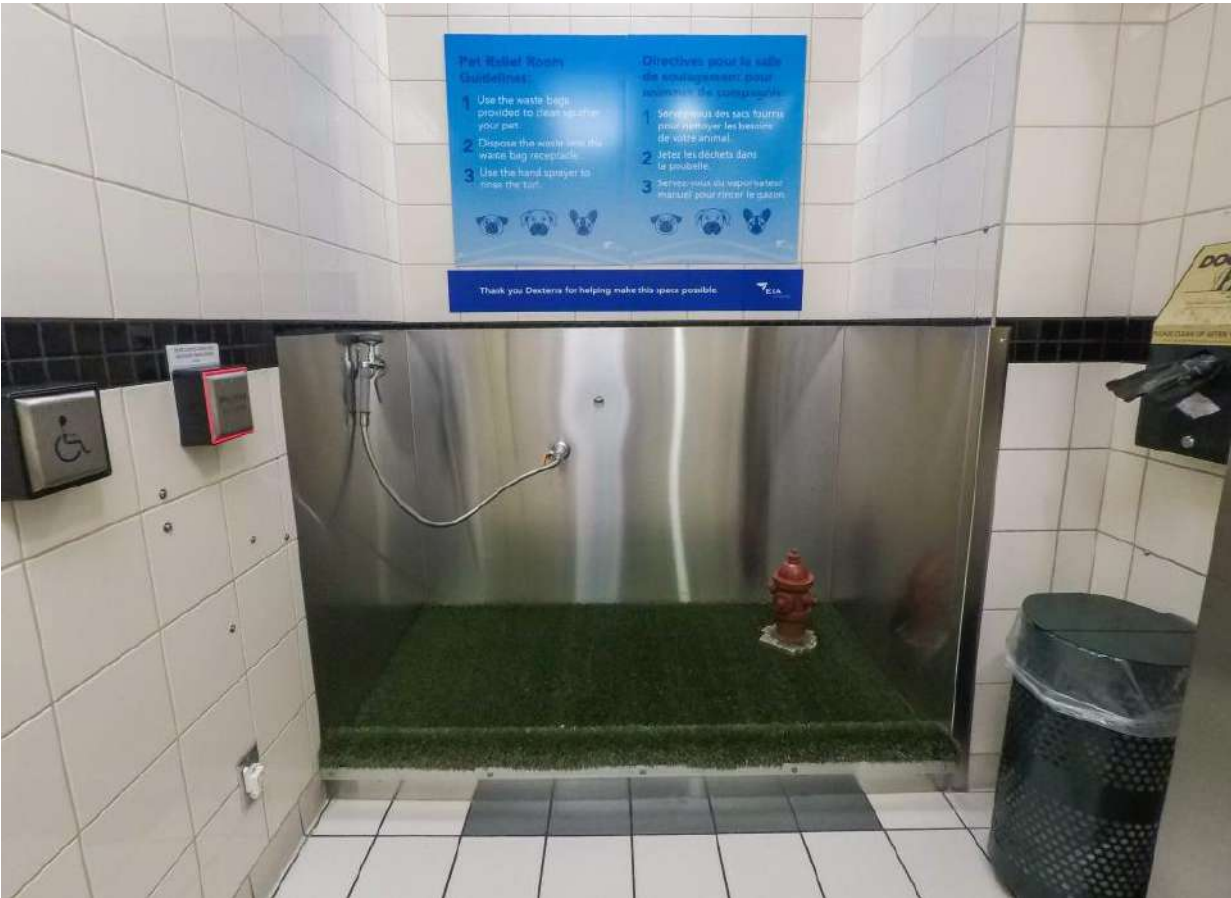

Image 19: SARA at Edmonton International Airport
(Source: <https://flyeia.com/services/travelling-with-pets/>)

19. Signage

- 19.1 Universally usable components must be kept in mind to make signage. [9]
- 19.2 In order to standardize the signs, signage details have been given in this chapter in line with 'Wayfinding manual – Design for way finding in airports' 2021.
- 19.3 Signage shall have contrasting colours as given below
- Internal signs:
 - Primary signs: Black (pantone black C) background with yellow (yellow C) text [13]
 - Secondary signs: Black (pantone black C) background with cyan (cyan 311C) text [13]
 - External signs:
 - Along the Kerb: Blue (RAL 5013) background with White (typeface white) text.
 - Road Signs: Blue (RAL 5013) background with White (typeface white) text. [13]
- 19.4 Signage shall have the message in 3 languages: local language, Hindi and English. Ekmukta font to be used for English and Hindi. Unicode font may be used for local language.
- 19.5 Character, Content and Layout shall be simple and eye-catching. [9]
- 19.6 Positioning and Viewing Distance to be kept in mind while placing the signage [9]
- 19.7 Signage shall be well lit. [9]
- 19.8 Material and surface finish should follow the existing standards being used for the signage at the airport.
- 19.9 Alternative formats etc. embossed letters with Braille (Audio/ Visual information, Maps and models) should be provided wherever possible. [9]
- 19.10 Wherever Braille signage is given, the signage should be accessible to a person walking with the help of a guiding stick and should be connected to the accessible route.
- 19.11 Standard drawings for the following signage have been given in this chapter: Accessible Parking (Figure 46), Pick up area (Figure 47), Drop of area (Figure 48), Accessible telephone booth (Figure 49), Accessible ramp (Figure 50), Airport Help (Reception Desk) (Figure 51), Priority Counter (Figure 52), Accessible toilet (Figure 53), Accessible Lift (Figure 54), Service Animal/ Pet Relief Area (Figure 55)



Image 20: Example of colours for Signage (Source: AAI - Sign Design Guideline Document, 2019)



Figure 45: Languages to be used for signage



Figure 46: Details of signage for accessible parking

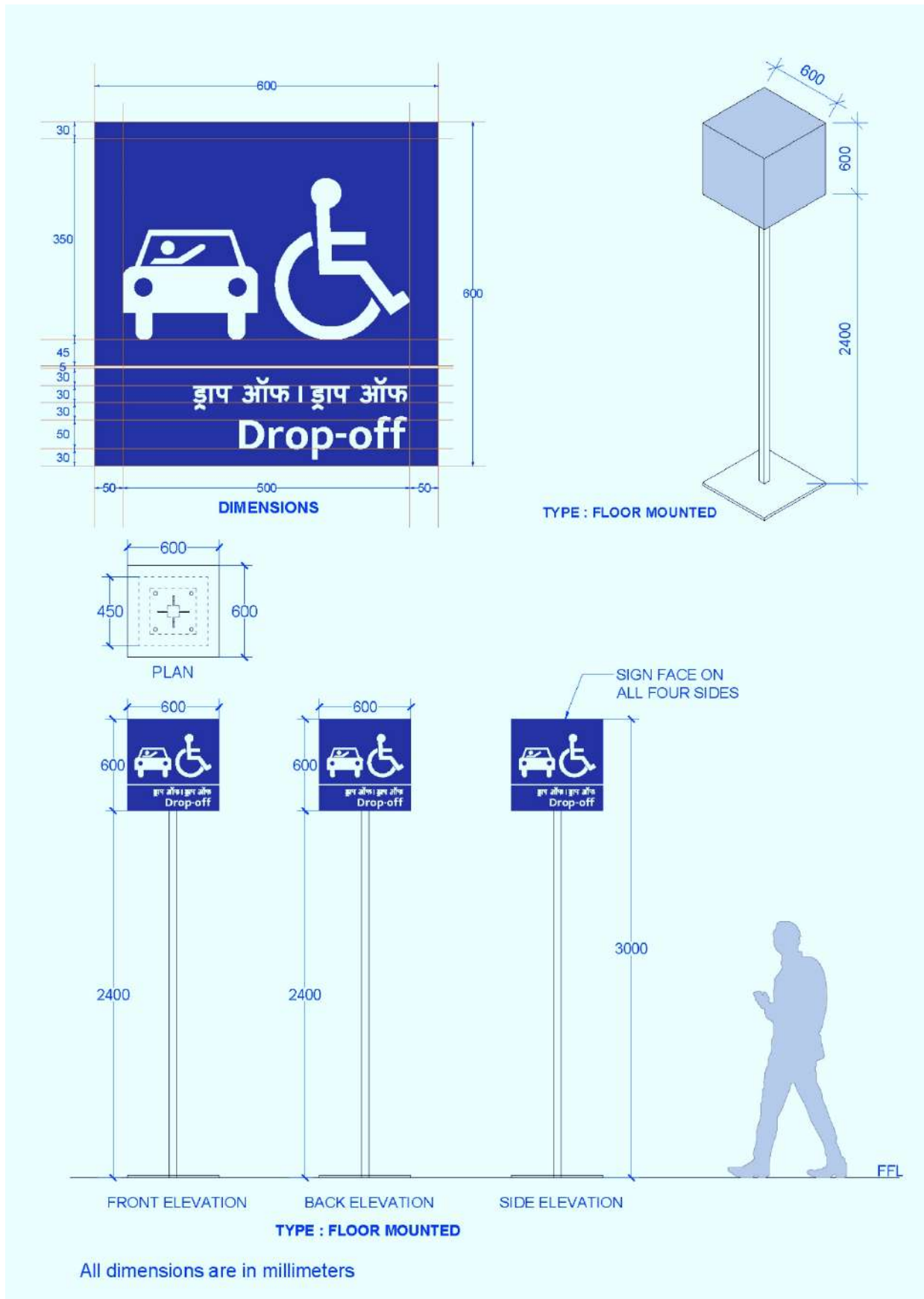

Figure 48: Details of signage for drop-off point at departure

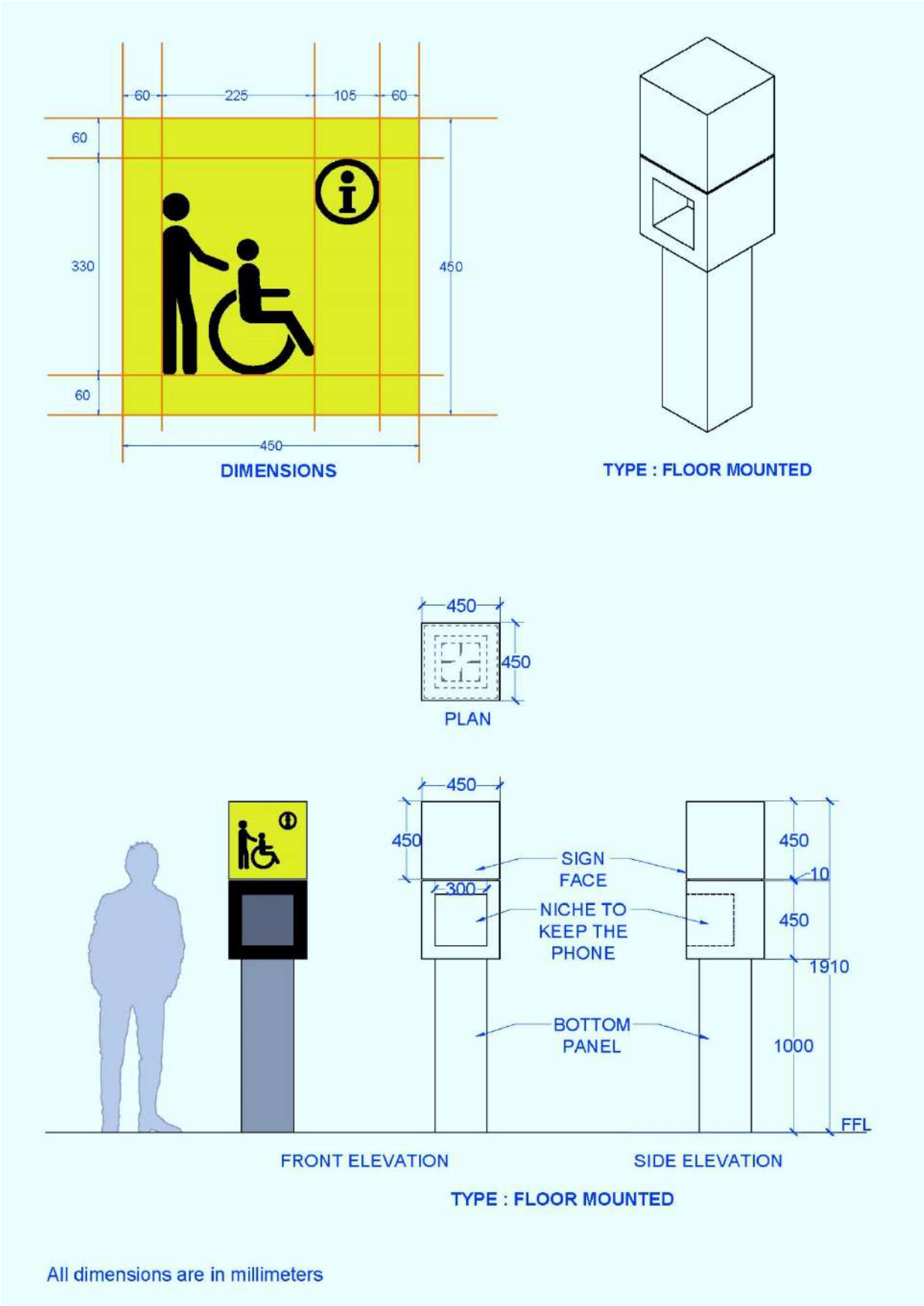

Figure 49: Details of Helpdesk call booth (to be given on city-side kerb) and its signage

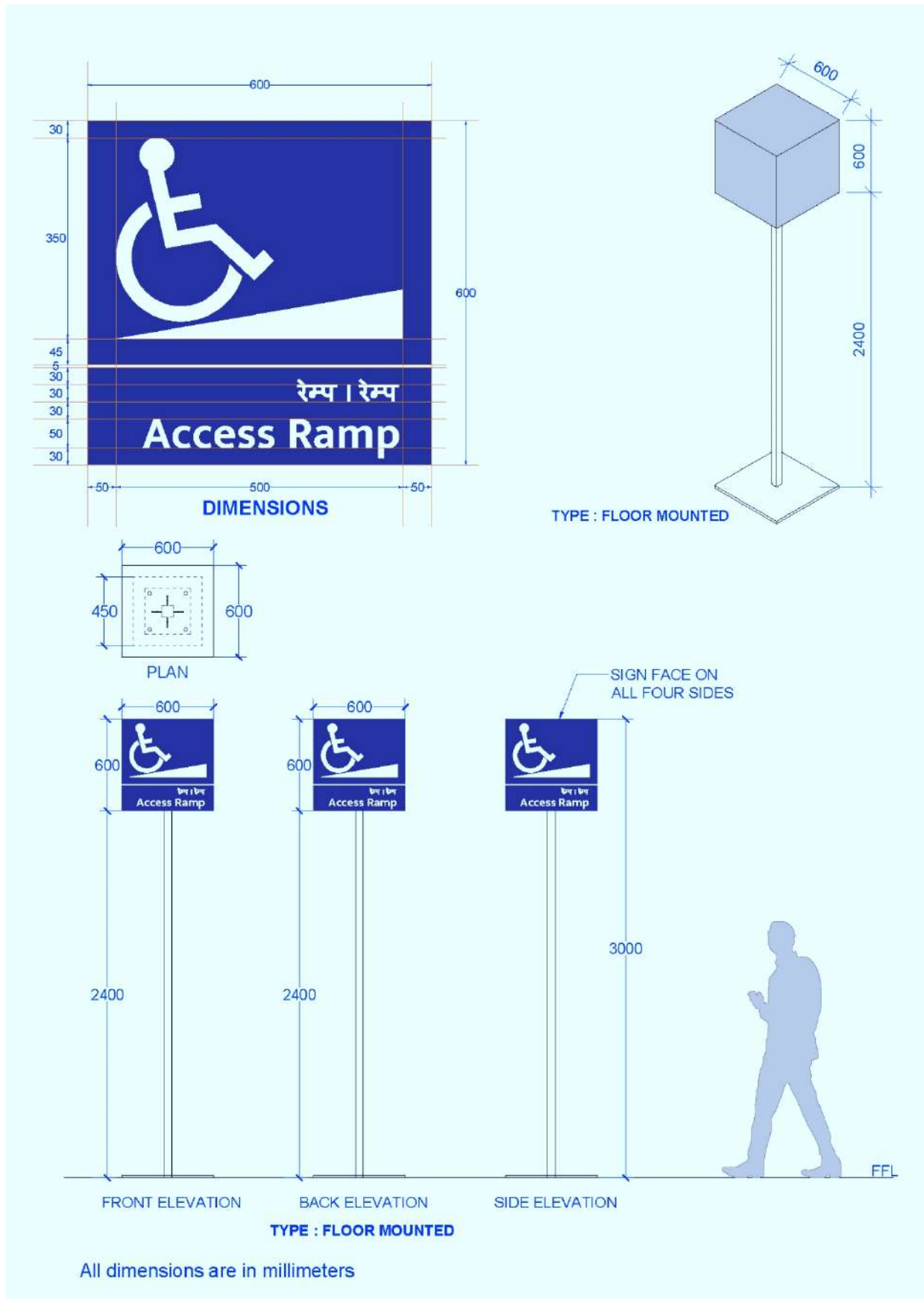

Figure 50: Details of signage near ramp along the kerb

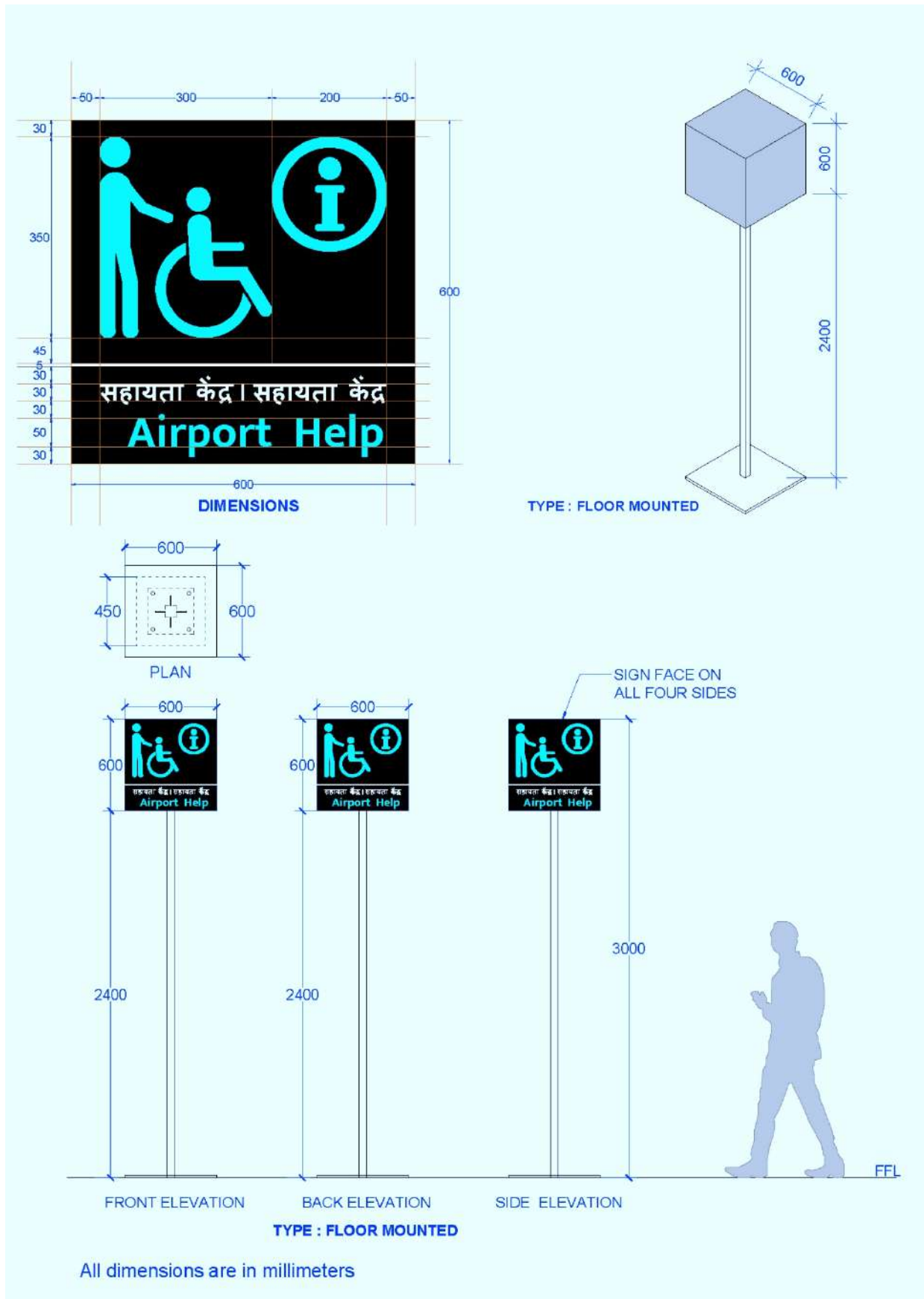

Figure 51: Details of signage for Airport Help

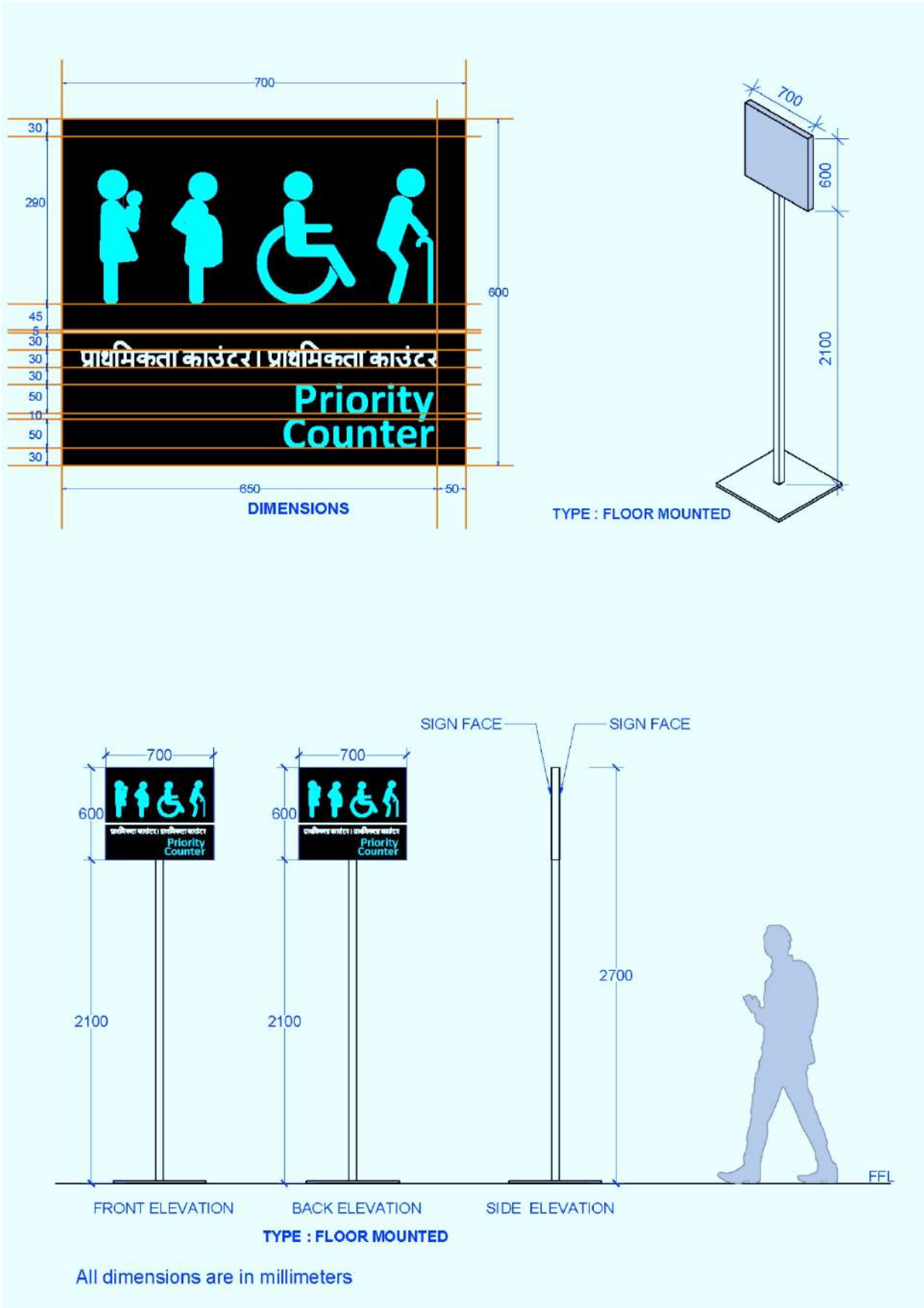

Figure 52: Details of signage for Priority Counter

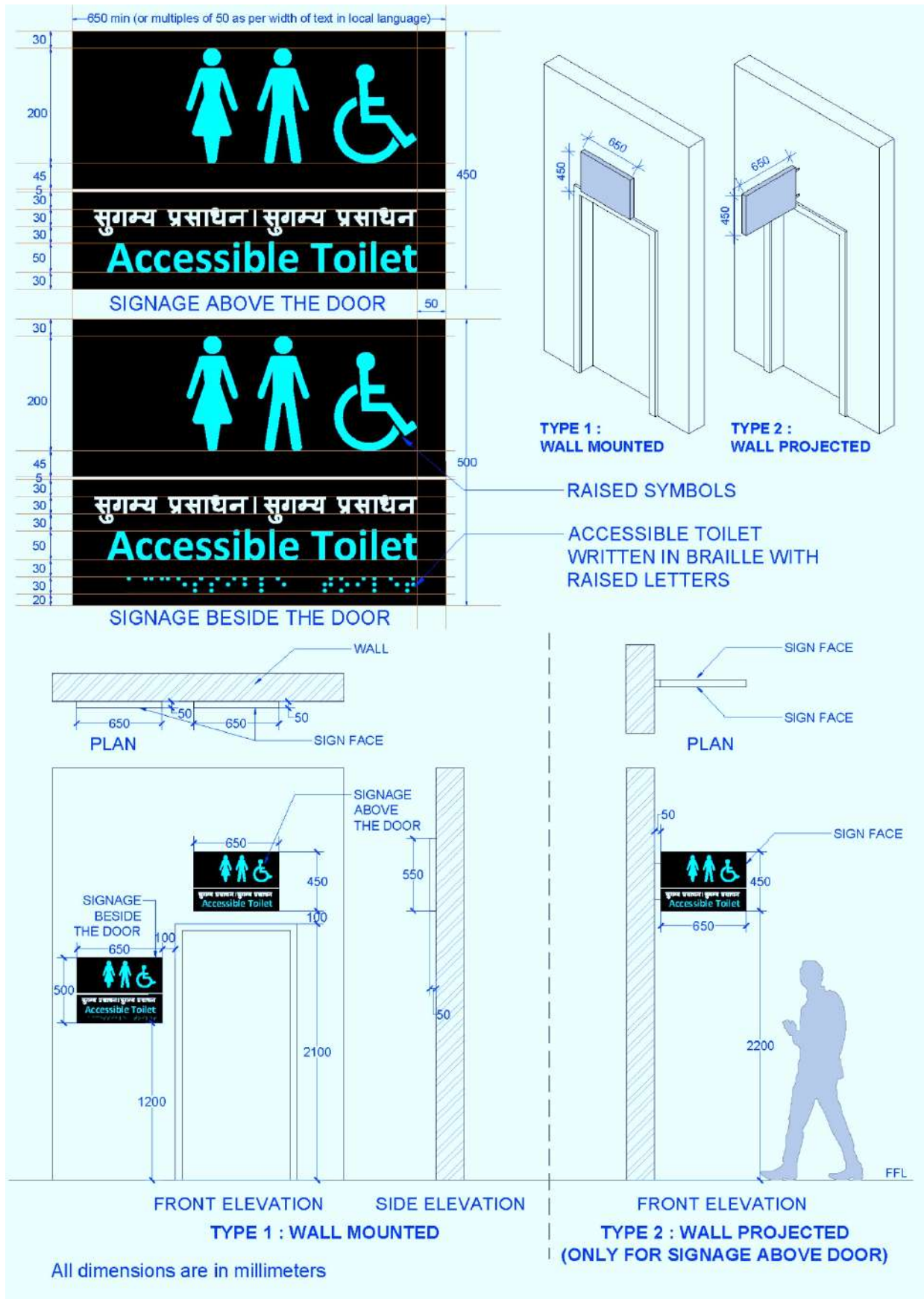

Figure 53: Details of signage for unisex accessible toilet

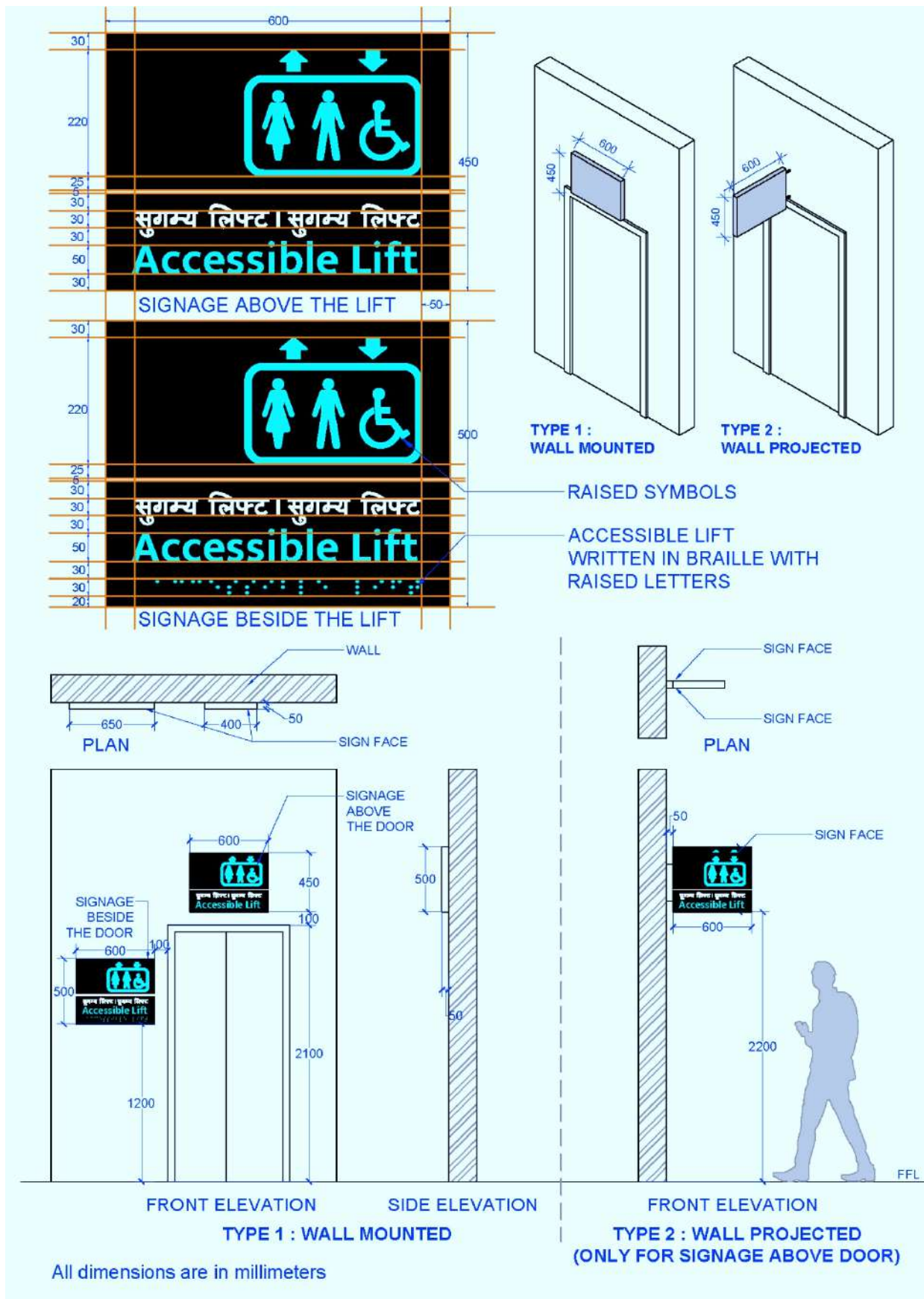

Figure 54: Details of signage for accessible lift

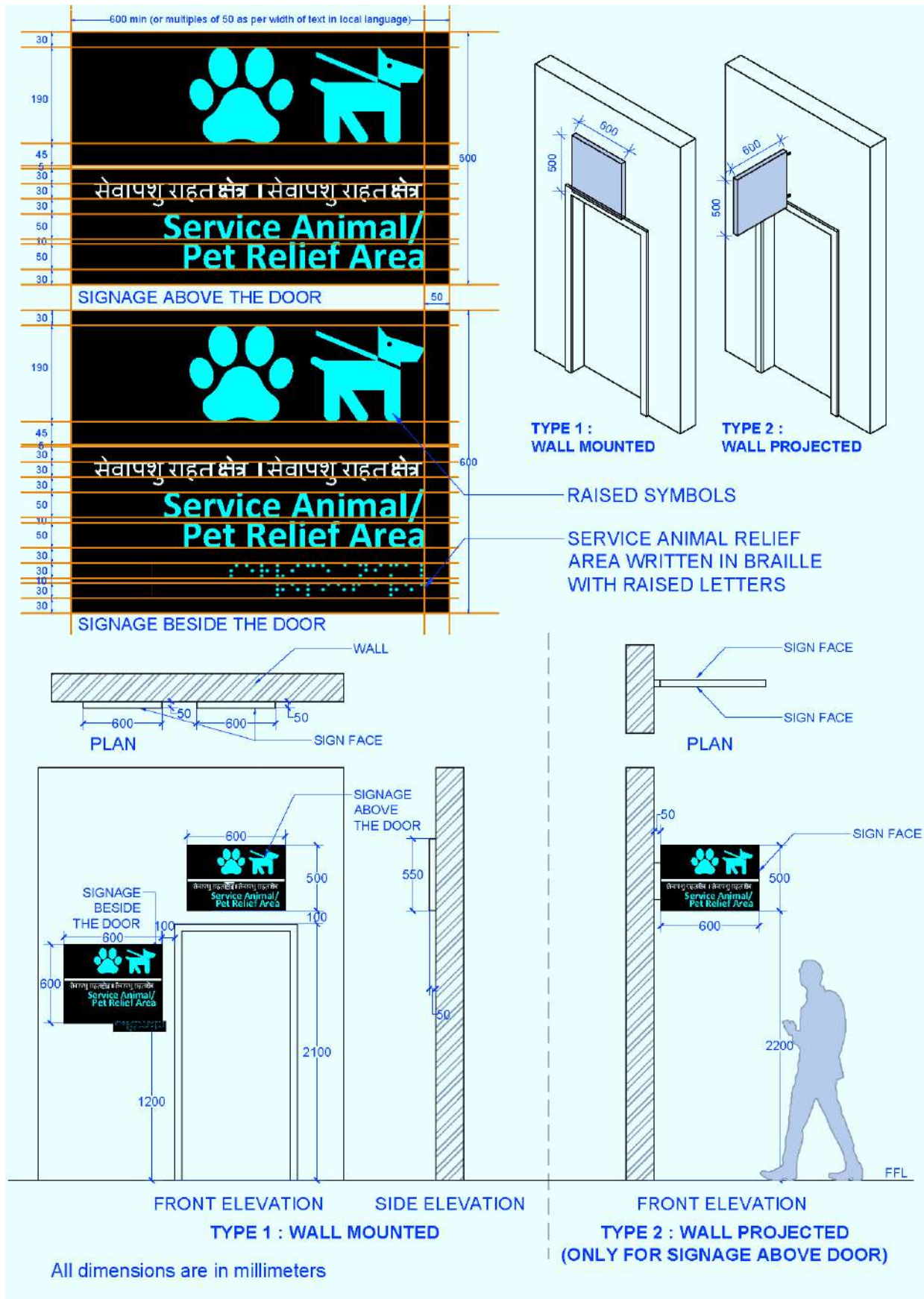

Figure 55: Details of signage for Service Animal/Pet Relief Area

20. Aerobridge and Ambulift

20.1 In all airports, for boarding any aircraft either an aerobridge or an Ambulift should be provided to facilitate the movement of people with reduced mobility.

20.2 Ambulifts are to be provided by Airport Operator/ Ground Handling Agencies/ Airlines.

20.3 Domestic airports where only ATR operations are carried, may be exempted from clause 20.1. However, appropriate arrangement shall be made for seamless movement of people with reduced mobility. Under no circumstances may the passengers be manually lifted. In case a ramp or any other facility is not available, the passenger may be seated in the wheelchair and the wheelchair may be lifted manually.

20.4 Antiskid material to be used for aerobridge flooring.



Image 21: Example of aerobridge at Chennai Airport



Image 22: Example of Ambulift

21. Low Floor Buses

21.1 Low floor buses are to be provided by airport operators/airlines.

21.2 Low floor buses to be used for seamless movement of wheelchair users.

21.3 Buses should preferably have retractable steps/ramps for smooth entry exit.

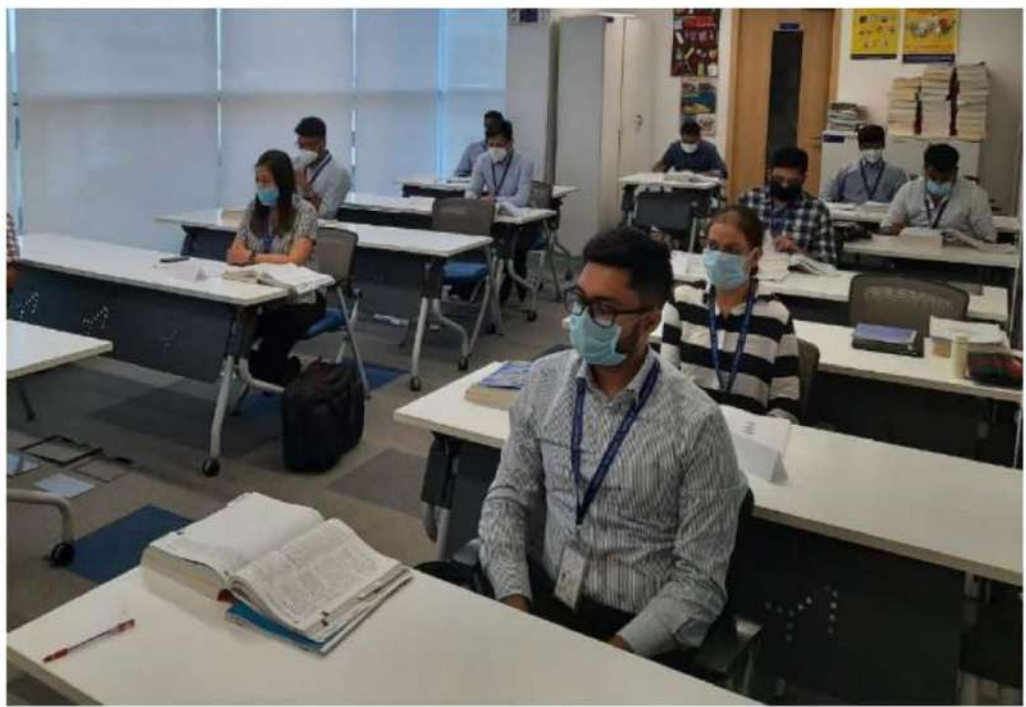

Image 23: Example of a bus with ramp at Lucknow Airport

Part B

Accessibility Features to be provided by Airlines





Part B: Accessibility features to be provided by Airlines

1. Facilities provided on the website

- 1.1 To help the airlines serve them better, the customers with an impairment should inform their complete requirement 48 hrs prior scheduled time of departure so that the airline makes necessary arrangements [4].
- 1.2 Airline websites shall include provisions for assistance request in advance
- 1.3 Airlines shall send communication to customers who confirm their requirement for a wheelchair or visual impairment assistance at least 48 hrs prior with the booking (adding SSR). Customers would receive a confirmation via SMS and Email [8]
- 1.4 All PWD related information shall be available on an airlines official website
- 1.5 Airline website and airlines' phone apps shall be WCAG 2.0 compliant [8]

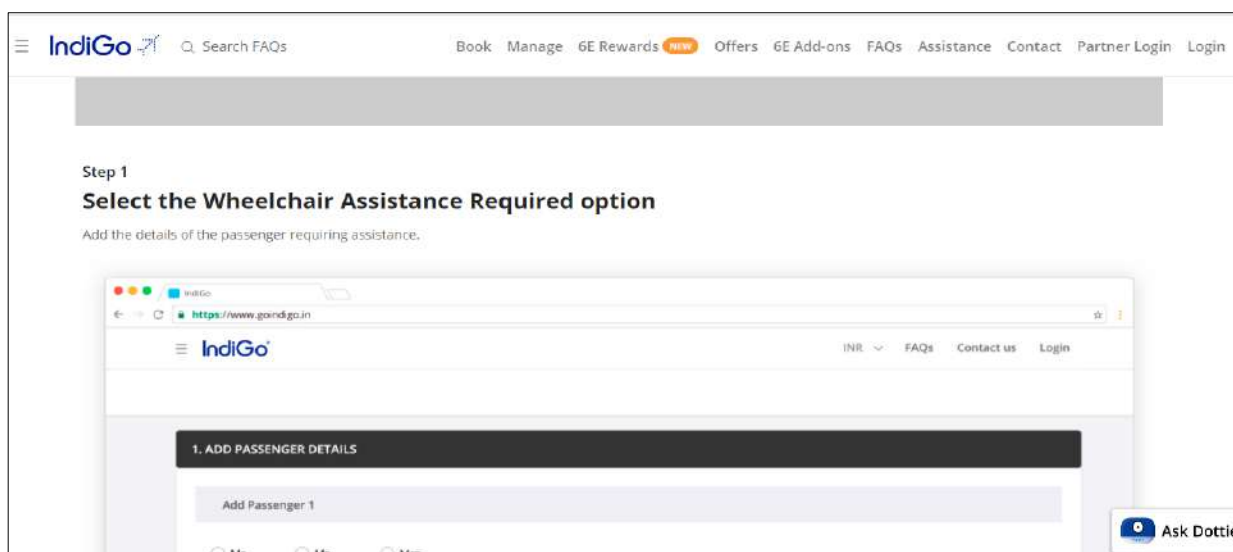

Image 24: Wheelchair assistance option on Indigo Airlines Website

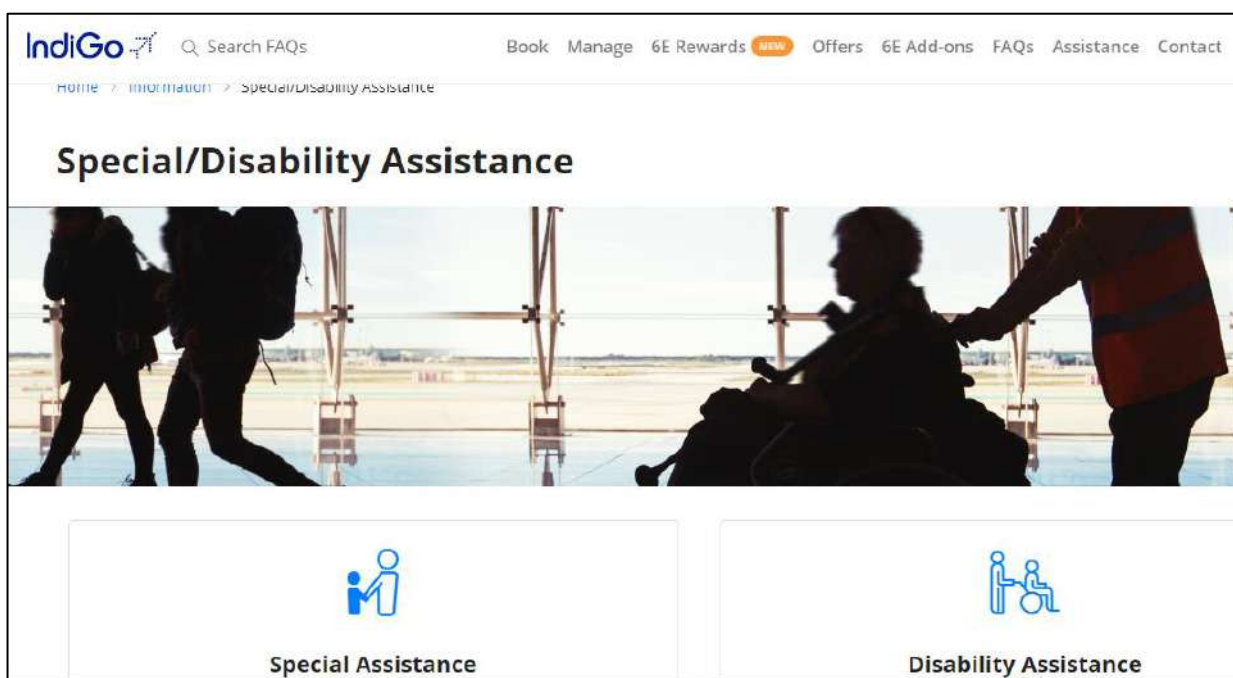

Image 25: Special assistance option on Indigo Airlines Website

2. Call Centre/Airline/ OTA ticketing

- 2.1 Call Centre agents should include the special service request while making a booking along with other relevant booking information once the request is made 48hrs prior departure (Subject to declaration by customer)
- 2.2 At the ticketing counter, customer facing staff should include the special service information during a fresh booking on the booking system and notify the customer (via automated email/SMS) accordingly once the request is made 48hrs prior departure. (Subject to declaration by customer)
- 2.3 Once a booking is confirmed, all relevant information for customer assistance at the airport should be part of the airline system and the required information is to be shared with the crew (Only if declared by the customer during booking).

3. Services at the Airport

- 3.1 Although the basic responsibility for providing wheelchairs in the terminal building is that of the airlines, the airport operator may provide extra wheelchairs for the convenience of their passengers in the terminal building.
- 3.2 In case a customer wants to check-in their own mobility aid (manual/battery powered), Airline shall ensure that wheelchair is duly tagged and sent to the baggage make up area with a service partner, to avoid damage. Also, all assistive aids should be sent with a service partner and not on the conveyor belt [8]



Image 26: Wheelchair service provided at Airports

4. Mobility Aid

- 4.1 Passengers traveling with their own mobility aid should contact the airline in advance (at least 48 hours prior) to make the necessary arrangements. If a passenger wants to use personal mobility equipment till the boarding gate, the Airline shall advise on personal mobility equipment accepted on different aircrafts, things to note when packing equipment for carriage, as well as time for the passenger to be present for check-in.

5. Travelling with a trained service dog

- 5.1 Customers are advised to check with the airline on the specific requirements of bringing service animals on flights.
- 5.2 For transit passengers, before booking by Call Centre, both primary flight and outbound connecting flight airlines should be agreeable to have service animals onboard the aircraft. The request and agreeability to be taken by the passenger before travel.
- 5.3 At the airport, the service animal and passenger will be escorted by airline staff throughout your period of stay at the airport. If the service animal needs to answer the call of nature, both of them will be brought to an appropriate facility to be provided by airport operator

6. Special assistance

- 6.1 Customer should not be insisted to check-in their assistive aids/equipment. They may give their assistive aids/equipment at the aircraft door, which would later be given back to the customer after landing of the aircraft.
- 6.2 Airlines should inspect the functioning of wheelchairs before they are provided to customers to ensure their safety
- 6.3 Wheelchairs should have footrest and belt for customer safety and support
- 6.4 Where wheelchairs or other mobility equipment or assistive devices are lost or damaged whilst being handled at the airport or transported on board aircraft, the passenger to whom the equipment belongs shall be compensated by the airline/airport operator/GHA/organisation responsible for such loss or damage. [4]
- 6.5 Airlines to ensure appropriate seats (non-emergency) with enough leg space (generally towards the forward/Aft rows, as per aircraft LOPA) should be blocked for customers travelling with guide dog seated near them.
- 6.6 When overnight accommodation is offered by the airline during in-transit off- loading due to unforeseen circumstances, persons with disability or reduced mobility shall be allocated accommodation suitable to their needs as far as practicable. [4]
- 6.7 Airlines should allow carriage of assistive devices free of charge as additional baggage subject to the limitation of the aircraft. [4]
- 6.8 Where a person with disability or reduced mobility is assisted by a safety assistant, the airline shall give such a person seat next to the persons with disability or reduced mobility. [4]
- 6.9 If a customer with learning disability speaks a language that the staff providing assistance is not familiar with, then the staff shall seek help from their manager.
- 6.10 When interacting with a visually impaired customer, staff should introduce themselves first. While assisting them through the terminal building, staff should also describe their surroundings. Also, when being handed over to a crew, a brief introduction of the customer and their requirement should be given.
- 6.11 For customers with hearing impairment, staff shall write down instructions and/or use gestures to explain the process.

7. Boarding/Ramp/Coach

- 7.1 A low floor coach or a ramp should be used, depending on coach type for comfortable boarding/deboarding for wheelchair users [8]
- 7.2 For customers with any other impairment, an airline staff should ensure that the customer is assisted till the aircraft and the crew is informed about their travel.
- 7.3 On the ramp, only a trained service partner and/or staff should support the customer with

disability in embarkation and disembarkation.

- 7.4 Airlines should preferably use aerobridges if available at airport. In case of remote parking, Airline should use a ramp to board a wheelchair user. If the ramp is not available with airlines then the ambulift facilities may be availed by the airlines with applicable charges.
- 7.5 Wheelchairs to be embarked (preferably before boarding all customers) and disembarked (preferable, after deplaning of all customers) to ensure customers comfort and safety. Under no circumstances, persons with reduced mobility may be manually lifted. If passenger is travelling with escort, the escort should be allowed to provide the assistance including pushing the wheelchair. In case of non-availability of ambulift, trained manpower may be allowed to lift the wheelchair under supervision. Such provision may be made in coordination with Ground Handling Agencies (GHAs) if required.



Image 27: Low floor buses and buses with in-built ramp



Image 28: Ramp provided by Airlines

8. Onboard

- 8.1 For convenience of visually impaired customers, a safety instruction card must be provided in braille or any other technological mean available in the future. However, the airline shall provide individual safety briefing to all visually impaired customers
- 8.2 Airline with on board entertainment (as applicable) may include content in accessible format, include safety video in sign language/subtitle.
- 8.3 Individual safety briefing should be provided to persons with disability or reduced mobility including their safety assistant by the cabin crew before take-off. Briefings should mainly cover safety and emergency procedures, cabin layout and relevant specialized equipment if available on board [8]
- 8.4 Airlines to ensure that visually impaired customers are made to touch the relevant equipment to assist them in understating the content of the safety briefing. Persons with hearing impairment customers are to be briefed verbally and through sign language.
- 8.5 Hearing impaired passengers may be able to lip read so crew to ensure that they speak slowly and use hand gestures for effective understanding and supporting the customer in understanding safety briefs
- 8.6 Customers shall be provided with assistance (while walking) in moving to and from the lavatory door. If assistance is required inside the lavatory, then customers must travel with a Safety Assistant.
- 8.7 For embarkation/disembarkation and in-flight use, the wide-body aircraft that have more than one aisle shall have an on-board wheelchair. The wheelchair shall be designed to be compatible with the maneuvering space, aisle width, and seat height of the aircraft on which it is to be used.

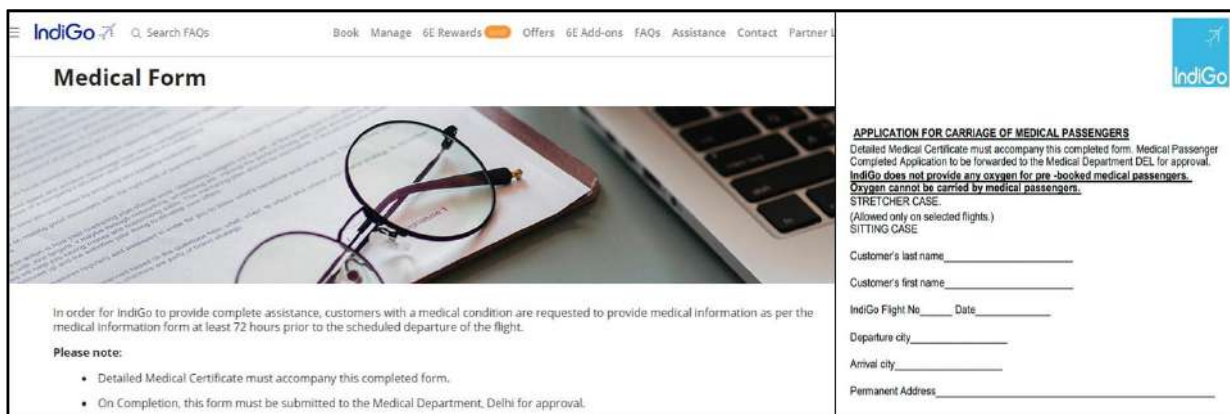

Image 29: Example of Aisle chair to be used on-board

(Source: <https://www.familyfuncanada.com/have-wheelchair-travel-anywhere/>)

9. Forms

- 9.1 Customers should ensure that they share all relevant information with the airline at least 48 hrs prior to their departure for required assistance
- 9.2 Assistance should be provided to all customers with disabilities and ensure that the airline teams are not confused between a medical customer and a customer with disability.
- 9.3 Airlines shall not request any customers to fill indemnity form before their travel except in case of medical requirements.
- 9.4 Only medical customers should be required to fill MEDIF form specially for stretcher/critical illness customers to ensure that they may travel by air safely, this section should be specially designed by the Chief Medical Officer of Airlines.



Medical Form

APPLICATION FOR CARRIAGE OF MEDICAL PASSENGERS
 Detailed Medical Certificate must accompany this completed form. Medical Passenger Completed Application to be forwarded to the Medical Department DEL for approval.
IndiGo does not provide any oxygen for pre-booked medical passengers.
Oxygen cannot be carried by medical passengers.

STRETCHER CASE:
 (Allowed only on selected flights.)

SITTING CASE:

Customer's last name _____
 Customer's first name _____
 IndiGo Flight No. _____ Date _____
 Departure city _____
 Arrival city _____
 Permanent Address _____

Please note:

- Detailed Medical Certificate must accompany this completed form.
- On Completion, this form must be submitted to the Medical Department, Delhi for approval.

Image 30: Medical form available on Airlines website

10. Training

- 10.1 Airlines should ensure that a Disability awareness training should be conducted for customer facing staff and ensure periodic refreshers are conducted to reiterate regulations, airline policies and SOPs on customer assistance with different types of disabilities for example hearing, visual, speech, wheelchair users, autistic etc.
- 10.2 The programs should focus on operational issues and soft skills, example – How to interact with a customer with visual or speech impairment, how to transfer a customer with dignity from their assistive device to our wheelchair and asking the customer if they would need assistance.



Image 31: Training to be given to Airline staff

11. Standardized Training and Audits

- 11.1 Airlines should ensure that customer facing staff is trained on “How to assist customers with disability” according to their respective roles. Customer feedback and service improvement should be shared for their specific stations so that over all service can be improved.
- 11.2 Disability training modules of consumer facing staff assisting customers with disability should be based on the following points:
- Best practices followed around the Globe by other airlines
 - Lessons & learning from incidents and Customer Feedback
 - SOPs training through role plays
 - Correct way to assist a customer with disabilities
 - Sensitisation towards their needs when interacting with them
- 11.3 Airlines should conduct periodic Internal Audits to ensure-
- Assisted devices are in good condition
 - Handling personnel are trained to safely load and secure mobility aids in the cargo hold

Part C

Accessibility Features to be provided by Security Agencies



Part C: Accessibility features to be provided by Security Agencies

1. Introduction

This chapter gives the information on the basis of AVSEC Circular No. – 01-2022 released by Bureau of Civil Aviation Security regarding ‘Standard Operating Procedure for screening of persons with special needs – Individual with disabilities and/or Individual with reduced mobility’, on 3rd February, 2022.

In order to improve the air travel screening process and to ensure that all persons, regardless of their personal needs and situations are treated with dignity, respect and courtesy, the Standard Operating Procedure (SOP) is laid down in the following paragraphs. This is aimed to better serve passengers with disabilities and/or with reduced mobility and to improve screening experience of such passengers along with carried mobility aids and assistive devices. [15]

2. General Principles:

- 2.1 All airport operators should make special arrangements to facilitate screening of persons with special needs as above, to ensure that the process is carried out efficiently keeping the dignity and privacy of the passenger in mind while ensuring adequate level of screening. This will include provision of suitable enclosed space for private screening of passengers covered in this SOP. [15]
- 2.2 The airport management / representative of the air carrier shall provide wheel chairs and render necessary assistance to facilitate the movement of the persons with special needs, when required. However, they would not normally be directly taken to the aircraft, except in case of ambulance passengers. [15]
- 2.3 Persons with disabilities and/or with reduced mobility should be made aware of the applicable security controls far enough in advance to facilitate their travel planning by airlines at the time of the booking of the tickets. [15]
- 2.4 Persons with disabilities and/or with reduced mobility should undergo searches as fully as the nature of their disability allows. If a wheelchair or stretcher is being used, this should also be searched. Hand-carried items should be screened according to the standard methods. [15]
- 2.5 If a passenger has difficulty on standing or waiting in line due to a disability or a medical condition, he/ she should duly inform the screening personnel who will assist in directing the passenger either to front of the queue or to a separate line. Passengers should be encouraged to indicate brief details of their disability at the time of booking of the ticket itself and in case of such prior information, airlines and security staff shall make advance preparation for such passengers. [15]
- 2.6 Screeners should use the following methods in dealing with persons with disabilities and/or with reduced mobility:
 - a) While interacting with persons with disabilities and/or with reduced mobility Screeners shall:
 - i) Be courteous and friendly;
 - ii) Treat everyone fairly and equally;
 - iii) Be respectful throughout the screening process;
 - iv) Assess the needs of the person to be screened;
 - v) Ask, and not assume the type of assistance needed;

- vi) Provide appropriate screening options. [15]
 - b) Generally, screeners should:
 - i) Focus on the person, not the disability, and treat all persons with respect;
 - ii) Remember that not all disabilities are obvious and that some may be hidden;
 - iii) Address the person directly and use clear, plain speech, not jargon;
 - iv) Ask how they may assist, and listen to the advice offered. Disabled people are best qualified to advise, on how to deal with their particular needs; and
 - v) Take into account specialized medical devices, and offer alternate screening methods with equivalent security outcomes, if recommended by the device manufacturer (for example insulin pumps); [15]
 - c) In all situations, security check should be performed in a dignified manner, requiring screeners to:
 - i) Explain why a different screening method is necessary;
 - ii) Explain the procedures to be followed;
 - iii) Verify that all special needs are correctly identified;
 - iv) Do not remove a medical device if required to monitor or manage a medical condition; and
 - v) Never impose help. [15]
 - d) In conducting a body search, screeners should:
 - i) Always offer a private search out of the view of other people, preferably in a private room, if available;
 - ii) Be able to recognize common place medical aids and employ suitable methods for searching such aids, including appropriate techniques for inspecting wheelchairs and stretchers;
 - iii) Ask the disabled person how best to help them and listen carefully to their needs;
 - iv) Invite the person to voice any discomfort and be prepared to use another technique, if necessary;
 - v) Crouch down to the user's height when searching someone in a wheelchair;
 - vi) Use firm but gentle movements and be discreet;
 - vii) Make sure that the person can stand without assistance before removing a cane, walking frame/walker or crutches to search them; and
 - viii) Arrange guidance for a blind person before removing a white cane or guide dog [15]
 - e) In searching baggage, screeners should:
 - i) Always remember to offer the option of a private search;
 - ii) Consider the fact that the person may be unable to lift the baggage on or off the X-ray conveyor belt;
 - iii) Consider the possibility that the person may not be able to hear properly or may not be able to see his or her baggage, in order to claim it following X-ray screening;
 - iv) Always call for a witness when searching the baggage of a blind person;
 - v) Repack bags carefully. The contents of a blind person's baggage should be replaced exactly as they were found;
 - vi) Ensure that all medication is carefully repacked; and
 - vii) Be discreet, especially when handling medical aids, and when handling personal possessions, particularly those related to hygiene or disability needs. [15]
- 2.7 Screeners and searchers should always remember that it is important to be thorough, but not necessarily rigid, as long as the job is performed to the necessary standard. [15]
- 2.8 When determining a search or screening method, security screeners should take into

account documentation provided by the passenger from their practitioner and advice from equipment manufacturers regarding the sensitivity of devices to measures such as full-body scanners and X-ray machines. Medical documentation is helpful but not essential.

[15]

- 2.9 While thorough checking is essential and the directives under AVSEC circular No. 23/2005 will be followed in letter and spirit; courtesy and attention to privacy and dignity will invariably be observed by screeners and searchers. [15]
- 2.10 In the case of a passenger having difficulty in walking or standing, the way his or her screening is conducted will depend on his or her level of ability/disability. [15]
- 2.11 Wherever testing is done for detection of explosives, in addition to ETD, help of dog squad may be taken as per need. However, the sensitivity of passenger and religious considerations may be kept in mind. [15]
- 2.12 The procedure laid down herein is not exhaustive, and therefore, in the situations/circumstances not exclusively dealt with in this SOP, common sense of the screener shall prevail depending upon the situation, circumstances and condition of the passenger. The paramount importance is to ensure aviation security and at the same time safeguarding the dignity of the passengers and preserving their privacy including improving their air travel experience. [15]

3. Screening of passengers with mobility disability, aids and devices:

- 3.1 When a passenger with mobility disability arrives at a screening point in his mobility device (manual or battery powered), in a wheel chair / scooter, he/she must be accompanied either by another traveling passenger or an airline representative (including Ground Handling Agency (GHA) of the airline) before he/she proceeds through security check. The accompanying passenger or the airline representative will be responsible for the passenger throughout the process of screening. [15]
- 3.2 If a passenger with mobility disability arrives at a screening point in a wheelchair and he/she is not accompanied by another traveling passenger or an airline representative, the airline's Customer Service should be contacted for assistance. [15]
- 3.3 The screening officer shall advise about the screening process to the passengers with mobility disability, using a wheelchair or other mobility aid that will be required prior to entering the Departure Lounge. Such passengers shall inform the screening officer about their ability to walk or stand independently before screening and may provide medical documents to describe their condition. However, showing medical documentation will not exempt a passenger from screening. [15]
- 3.4 The Screening points should have full-body scanners/Door frame metal detector (DFMD), chairs and walking aids for semi ambulant walking-aid user. [15]
- 3.5 If a PRM passenger expresses concerns, he/she may request a physical search in lieu of a search using detection systems such as HHMD, DFMD or Body scanners. In such a case, private search should be arranged. [15]
- 3.6 At the screening point, depending upon the ability of the passenger to walk, he/she will be requested to walk through the Full-body scanners/DFMD unaided. If he/she cannot walk, it is the responsibility of the accompanying traveling passenger or the airline representative to push the passenger in the wheelchair unless it is self - driven. [15]
- 3.7 In accordance with Airline's policy, there may also be non-travelling support personnel in attendance to board the aircraft and lift the passenger into his/ her seat. This support person must be accompanied by the airline representative. [15]
- 3.8 The support person will be escorted by an Airline representative at the time of boarding/

- disembarkation. [15]
- 3.9 In case of non-availability of full-body scanners and a passenger with mobility disability has difficulty to stand, raise arms, etc. without support, shall be subjected to a pat-down by a screening officer of the same gender or in case of transgender as per his/her decision. Screening officers shall obtain consent to conduct a pat-down. Before a pat-down is carried out, the screener shall offer the use of a private search room/enclosure which will be made available upon request. [15]
 - 3.10 If the passenger can stand but cannot walk, he/she can be screened by undergoing a pat-down while he/she stands beside the wheelchair or scooter. [15]
 - 3.11 If a passenger cannot stand, he/she should be offered a chair for screening and subjected to a pat-down thereafter. [15]
 - 3.12 If there is an alarm by the Full-body scanners, DFMD, Hand held metal detector (HHMD) or other technology, the same must be resolved. If the alarm cannot be resolved, the passenger will not be permitted beyond the check point. [15]
 - 3.13 The passenger's wheelchair or scooter will be inspected, including the seat cushions and any non-removable pouches/pockets. It will be tested for traces of explosives. Removable pouches will be x-ray screened. [15]
 - 3.14 Any carry-on bag or document with the wheelchair passenger shall be passed through the x-ray screening. [15]
 - 3.15 Walkers, crutches, canes or other mobility aids and devices which can be separated from passengers shall be subjected to the x-ray screening. If any of these items are not fitted through the x-ray, the screening officer shall inform the supervisor, who in turn will ensure that appropriate security controls are applied. The DGCA Dangerous Goods Regulation on mobility devices shall be adhered to before loading the mobility aids on aircraft. [15]
 - 3.16 If a person objects to proceed through the DFMD on justified medical or other ground, he/she will be allowed passage through an alternative way by the frisking officer and then subjected to screening by pat-down search and HHMD where permissible. [15]
 - 3.17 If a person refuses to undergo screening, the frisking officer will inform the supervisor, who will direct what further action is to be taken. The concerned passenger will not be allowed entry past the screening point without security check. [15]
 - 3.18 Only when satisfied that a person is not carrying any prohibited or dangerous article, the screening officer shall allow the person to proceed beyond the screening point. [15]

4. Screening of passenger with prosthetics:

- 4.1 The passenger with prosthetics, cast, support braces, sling or support appliances on request, may be accompanied, by an airline representative (including GHA of the airline), preferably of the same gender as that of the passenger or in the case of Transgender as per his/her decision. [15]
- 4.2 The passenger should inform the ASG/APSU of the existence of a prosthetics, his or her ability and of need for assistance before screening begins. Passengers can use notification card or Unique ID for persons with disabilities (UDID) or other medical documentation to communicate discreetly with screening officers. However, showing this card or Unique ID for persons with disabilities (UDID) or other medical documentation will not exempt a passenger from additional screening when necessary. [15]
- 4.3 Dignity and privacy of the passengers should be borne in mind during the entire process of security screening. Where the officer needs to see the prosthetics, care should be taken against exposing any sensitive areas. The passenger needs to be handled with sensitivity. [15]

- 4.4 Airline representative (including GHA of the airline) and/or any other accompanying person shall be frisked and checked before allowing them access to the passenger with prosthetics at the screening point. [15]
- 4.5 The passenger will first pass through the full-body scanners / DFMD and further necessary security checks. [15]
- 4.6 The prosthetics, cast, support braces, sling or support appliance are subject to additional screening by ASG/APSU. [15]
- 4.7 During the screening of prosthetics, cast, support braces, sling or support appliance ASG/APSU may use visual check, ETD and X-ray screening depending on the circumstances of each case. ASG/APSU will also use technology to test the prosthetics, cast, support braces, sling or support appliance for traces of explosive material. [15]
- 4.8 The passenger should then be taken to a private screening point and made to sit comfortably. He/she will receive additional screening including a pat-down. If necessary, screening through ETD will be adopted. While dealing with the prosthetic device and during taking off and putting on clothes, the privacy of the passenger should be maintained. [15]
- 4.9 A prosthetic appliance that does not have any foam padding cover under which any weapon/explosive can be concealed and in which the steel rod of the appliance is visible, maybe screened by visual inspection and ETD checks only, without removing it. However, in rare cases where there is sufficient justification including profiling of the passenger, X-Ray screening may be resorted to. The justification for subjecting a prosthetic limb to X-Ray screening shall be recorded by the screener in a register. During visual inspection, care should be taken that sensitive parts are not exposed. [15]
- 4.10 Screening of prosthetic appliance covered with foam padding (in which the steel rod of the appliance is not visible) shall include visual inspection, ETD checks and X-ray screening. X-ray screening of such appliances in which a weapon could be concealed under the foam padding will be done in all cases unless it can be physically checked to ensure that no weapon is concealed inside the padding. [15]
- 4.11 If X-Ray screening of the prosthetic limb is required, such passenger should be taken to a private screening point and made to sit comfortably for taking off his/her prosthetic limb. While dealing with the prosthetic device and during removing and wearing clothes, the privacy of the passenger should be maintained along with the proper log entry. [15]
- 4.12 If screening of the prosthetic limb is required, then the screening will be carried out in the private screening area by two officials, one to handle HHMD and pat-down and the other to inspect the prosthetics, cast, support braces, sling or support appliance and subject them to additional screening. [15]

5. Screening of passengers who cannot remove shoes, medical device or bandages

- 5.1 Passengers who cannot remove their shoes due to a medical condition should inform the supervisor at pre-embarkation security checkpoints before screening. [15]
- 5.2 Passenger can be screened using Full-body scanners / DFMD and/or a whole-body pat-down search. [15]
- 5.3 The shoes may be subjected to an additional screening like ETD, etc. [15]
- 5.4 Passengers can be screened without disconnecting external medical devices and submitting them for x-ray. Such devices include:
 - i) Insulin pumps.
 - ii) Hearing aids

- iii) Cochlear implants
 - iv) Spinal stimulators
 - v) Bone growth stimulators
 - vi) Ostomies [15]
- 5.5 Under most of the circumstances, a passenger can conduct a self-pat-down of these devices followed by ETD screening of his / her hands. [15]
- 5.6 The devices should also be physically checked against any outside interference in the manufacturing. [15]
- 5.7 Casts, braces and support appliances will be thoroughly inspected without exposing sensitive areas as far as possible. ETD screening will also be used to test for traces of explosive materials, where possible. [15]
- 5.8 In case of bandages and/or dressing, while caution will be observed during pat-down, it needs to be ensured that the covered area is free of threat item. Metal detector, observation and self-pat-down followed by ETD checks may suffice in most cases. [15]
- 5.9 Passengers with metal implants will be subjected to a thorough pat-down, and the metal alarm should be resolved satisfactorily. The full-body pat-down should include the following:
- i) It should concentrate on the upper legs and torso.
 - ii) Special attention should be given to the chest and abdomen areas of the body.
 - iii) Particular focus should be on any skin surface abnormalities or wires or tubes exiting the body that may be signs of any implanted device. [15]
- 5.10 In accordance with BCAS instructions, all airport operators shall display a board near pre-embarkation security checkpoints in a prominent way stating that Full Body Scanner/DFMD/HHMD is safe for pacemaker and for pregnant ladies. [15]

6. Screening of visual/ hearing and speech impaired passengers:

- 6.1 The passenger with visual /hearing and speech impaired is to be assisted at access control and pre-embarkation security checkpoints with due diligence and care. These passengers require individual attention or assistance right from terminal entry/exit point also on embarkation /disembarkation and during flight. [15]
- 6.2 Visually impaired passenger-**
- 6.2.1 The Airport operator and Aircraft operator shall arrange for handy signage chart in braille language for visually impaired person at helpdesk and check in counter respectively. [15]
- 6.2.2 If passenger identifies himself /herself as visually impaired person while check-in, airline check-in/escort staff should assist him/her for validation of itinerary/photo ID check at the time of check-in. Boarding pass, baggage reclaim portion (if any) to be handed over to passenger by Airline concerned. [15]
- 6.2.3 Airline escort will assist visually impaired passenger for his/her registered baggage screening process. In case baggage requires physical inspection, on approval of visually impaired passenger the airline escort will assist for unpacking for physical search and packing of registered baggage once the search is completed. [15]
- 6.2.4 At the security checkpoint once passenger identifies himself/herself visually impaired, then ASG/APSU personnel should support him/her in placing his/her cabin baggage (if any) and personal belongings in the tray for hassle-free screening. [15]
- 6.2.5 In case the passenger is assisted by an escort of airline staff, ASG/APSU personnel must speak to the visually impaired passenger directly and not to the escort. [15]

- 6.2.6 Once the passenger has identified himself/herself as visually impaired and he/she needs to step on to the podium, then, ASG/APSU personnel must assist such passenger in standing on the podium. [15]
- 6.2.7 ASG/APSU personnel should first obtain consent before start of the frisking process, from the visually impaired passenger verbally and the passenger's nod or verbal acknowledgement should be accepted as understood. [15]
- 6.2.8 ASG/APSU personnel must give verbal directions to the visually impaired passenger during the frisking process so that the passenger is aware of the situation. [15]
- 6.2.9 In case of alarm while frisking visually impaired passenger, ASG/APSU personnel will assist and guide for removal and checking of the suspected item. [15]
- 6.2.10 The visually impaired passenger's walking aid and personnel belongings must be provided to them as soon as the frisking is over and they must not have to reach for it on their own. [15]
- 6.2.11 In case any restricted article needs to be removed or the baggage requires physical inspection, airline escort / ASG/APSU personnel will assist visually impaired passenger for unpacking for physical search and packing of cabin baggage once the search is completed. ASG/APSU personnel shall ensure to replace all items where they were originally located. [15]
- 6.2.12 ASG/APSU personnel should:
- i) Be tactful, courteous and use caution, while screening;
 - ii) Assist persons through the Full-body Scanner / Door Frame Metal Detector (DFMD);
 - iii) Offer screening options to stand or sit for primary screening;
 - iv) Provide an option for private screening;
 - v) If requested, allow the escort of same gender to assist, and go through a security check;
 - vi) Ensure that guide dog is not separated from a person during screening;
 - vii) Make or put up identification mark on the cabin baggage;
 - viii) Always call for a witness when searching the cabin baggage of a blind person;
 - ix) Repack bags carefully. The contents of a blind person's baggage should be replaced exactly as were originally located;
 - x) On completion of the search, it is important to thank the person for cooperation. [15]

6.3 Hearing and/or Speech impaired passenger -

- 6.3.1 If passenger identifies himself as hearing & speech impaired person while check-in, airline check-in/escort staff should speak slowly, as some passenger know how to lip-read. Check in staff may also keep bilingual written boarding instructions in order to guide them properly. [15]
- 6.3.2 Airline check-in /escort staff will use basic gesture to ask the passenger for validation of itinerary/photo ID check at the time of check-in. Boarding pass, baggage reclaim portion (if any) to be handed over to passenger by Airline concerned. [15]
- 6.3.3 When a passenger arrives at a screening point and identified himself/herself as Hearing and Speech impaired passenger, ASG/APSU personnel should speak slowly, as some passenger know how to lip-read. [15]
- 6.3.4 ASG/APSU personnel should first obtain consent from such passenger verbally (speaking slowly) and passenger's nod or verbal acknowledgement should be accepted as understood, before the start of frisking process. [15]
- 6.3.5 The frisking process should be shown in pictorial and/or written format, for passenger understanding. [15]

- 6.3.6 In case the passenger is assisted by an escort or airline staff, ASG/APSU personnel must inform the process to the passenger directly and not to the escort. [15]
- 6.3.7 Usually hearing aids or cochlear implants are not required to be removed; however, this may require additional screening including a pat-down and inspection of a device by ASG/APSU. [15]
- 6.3.8 In case of alarm while frisking hearing / hearing & speech impaired passenger, ASG/APSU personnel may ask for the removal of the suspected item and check. To resolve the alarm, ETD screening will also be used to test for traces of explosive materials if required. [15]
- 6.3.9 At the X-ray point, if the ASG/APSU personnel want to conduct physical-check of the cabin baggage, they should use hand gestures and/or show the X-ray screen to help the passenger in understanding. [15]
- 6.3.10 ASG/APSU personnel should:
- i) Be tactful, courteous and use caution, while screening;
 - ii) Speak in a normal tone and pace, clearly and concisely;
 - iii) Use hand signals and gestures to help express spoken direction (pointing and nodding);
 - iv) If requested, allow the escort of same gender to assist, and go through a security check;
 - v) Maintain eye contact at all times and speak directly to the person with the impairment and not to the escort;
 - vi) Point out visual alarms by physical indication;
 - vii) If communication difficulties persist, screening officers shall use written instructions to communicate to the passenger;
 - viii) On completion of the search, it is important to thank the person for cooperation. [15]

7. Screening of passengers with service animals (Guide Dog):

If the passenger has a guide dog, the instructions issued by AIC No. 09/1984 of DGCA shall be implemented. If the guide dog, is permitted to be carried on board, the following instructions shall be followed:

- 7.1 The guide dog must be appropriately trained, certified, vaccinated as per DGCA guidelines. [15]
- 7.2 The animal must be wearing a harness, vest, or other identifiers that it is a guide dog,
- 7.3 The passenger must maintain control of the guide dog, at all times; He or she should not be separated from the guide dog; [15]
- 7.4 The screening officer should ask for the permission of the passenger before touching the guide dog; [15]
- 7.5 Guide dogs are screened using full-body scanner or door-frame metal detector followed by a pat-down; there are three options:
- i) The guide dog goes first and the passenger follows holding the leash.
 - ii) The passenger goes first holding the leash and the guide dog follows.
 - iii) The passenger and the guide dog go together. [15]
- 7.6 Regardless of who goes through the full-body scanner or door-frame metal detector first, the screening officer will perform a physical inspection of the guide dog and its belongings (collar, harness, leash, backpack, vest, etc.). The belongings will not be removed from the guide dog; [15]
- 7.7 The passenger should not make contact with the guide dog (other than maintaining control

- of the leash) until the guide dog has been cleared; and [15]
- 7.8 Medication for the guide dog will be subjected to x-ray and additional screening, if required. These should also be subjected to separate screening, from other items of the passenger cabin baggage. [15]

8. Screening of passengers having Alzheimer's, Dementia, Aphasia, Autism or Hidden Disabilities:

- 8.1 The passenger having Alzheimer's, Dementia, Aphasia or Autism disease on request, may be accompanied, by an airline representative (including GHA of the airline), preferably of the same gender as that of the passenger. [15]
- 8.2 The accompanying passenger or the airline representative (including GHA of the airline) should inform the ASG/APSU personnel about such disease in the passenger, his or her ability and need for assistance, if any, before screening begins. Passengers can use notification card or Unique ID for persons with disabilities (UDID) or other medical documentation to communicate discreetly with screening officers. However, showing this card or other medical documentation will not exempt a passenger from screening. [15]
- 8.3 ASG/APSU personnel shall inform the option of being screened in a private screening point. On opting for the private screening option, such passenger along with accompanying passenger or the airline representative (including GHA of the airline) should then be taken to a private screening point for screening. Such passengers shall be screened without separating them from accompanying passenger or the airline representative of the same gender, and go through a security check in a desired manner up to the satisfaction of the screening personnel. [15]
- 8.4 If accompanying passenger provides assistance during screening, he/she will need to be re-screened. [15]

9. Screening of Ambulance passenger:

- 9.1 Due to the exigencies of their exceptional medical conditions/illness, some passengers are directly taken through the Vehicle-gates to the aircraft for boarding. [15]
- 9.2 In such cases, as far as possible, the airport operator/airline should provide its own ambulance. [15]
- 9.3 The passenger and all occupants of the vehicle should be subjected to a pre-embarkation security check at the security gate by the ASG/APSU under the supervision of an officer, not below the rank of an Inspector. The ambulance should be permitted to proceed to the aircraft only after this check has been completed. [15]
- 9.4 In case the ambulance is privately owned or hospital provided, it must be led by the "follow me" vehicle of the airport operator. The ASG/APSU shall check to ensure that the vehicles do not carry anything objectionable and are not being accompanied by unauthorized persons or persons who have no need to be in the vehicles. Such an ambulance will be escorted by ASG/APSU). [15]
- 9.5 All occupants of the vehicles, unless exempted, must be screened at the gate before allowing entry into the airport. [15]
- 9.6 The movement of the ambulance should be coordinated well in advance by the airline operator with Chief Aerodrome Security Officer (CASO) and airport operator. [15]

10. Screening of medication and associated supplies:

- 10.1 All medications and associated supplies (i.e., syringes, sharps disposal container, pens, infusers etc.) are allowed through the checkpoint only after they have been screened. [15]

- 10.2 Medication and related supplies are normally screened through x-ray. [15]
- 10.3 Passengers have the option of requesting a visual inspection of medications and associated supplies with due reason. [15]
- 10.4 Any medication that cannot be cleared visually must be submitted for X-ray screening.
- 10.5 Medically necessary Liquid, Aerosol and Gels (LAGs) are permitted in excess of 100 ml on a need basis after screening. These items are subject to additional screening through visual inspection and ETD swipe, if necessary. [15]
- 10.6 If a passenger has medically necessary LAGs, he or she needs to:
 - i) Limit the amount to what is reasonably necessary for the itinerary;
 - ii) Separate these items from the other LAGs;
 - iii) Declare the items; and,
 - iv) Present these items for additional inspection on reaching the security checkpoint. [15]

11. X-ray screening of respiratory equipment:

- 11.1 Supplemental oxygen and other respiratory-related equipment are permitted through the checkpoint once they have been screened. This is subject to DGCA regulations also. [15]
- 11.2 If a passenger can disconnect from the oxygen, the oxygen container will undergo x-ray screening. [15]
- 11.3 Passenger(s) who cannot disconnect from respiratory equipment will be screened by undergoing a pat-down. [15]
- 11.4 Respiratory equipment that is not x-rayed will be visually and physically inspected, and will be subject to ETD screening. [15]

Part D

Guidelines for Evacuation Protocol



Part D: Guidelines for Evacuation Protocol

The purpose of this chapter is to identify the unique problems associated with emergency evacuation of persons with disabilities from a facility such as airports. This information provides a general guideline of evacuation procedures for persons with disabilities for fire and other building emergencies. The following points about various disabilities should be considered while making the evacuation protocols and revising the existing protocols.

1. General

- 1.1 Always ask someone with a disability how you can help before attempting any rescue technique or giving assistance. Ask how they can best be assisted or moved, and whether there are any special considerations or items that need to come with them. [16]
- 1.2 If the person has a service animal, it is the animal owner's responsibility to assess whether or not it is safe for the animal to work through the emergency situation. [17]
- 1.3 To make this decision, the service animal owner will need information as to the nature of the hazards they are expected to face and any changes to the physical environment [17]

2. Visual Impairments

- 2.1 Most persons with visual impairments will be familiar with their immediate surroundings. In the event of an emergency, tell the person with a visual impairment the nature of the emergency and offer to guide the person to the nearest emergency exit. [18]
- 2.2 Tell the person the nature of the emergency and offer to guide him/her by offering your left/right elbow (this is the preferred method when acting as a "Sighted Guide"). Do NOT grasp a blind or person with low vision's arm. [18]
- 2.3 Do not shout at a person who is blind or has reduced vision. Speak clearly and provide specific directions. [17]
- 2.4 As you walk, tell the person where you are and advise him or her of any obstacles. When you reach safety, orient the person to where he or she is and ask if any further assistance is needed. [19]
- 2.5 To communicate with someone who is deaf-blind, trace letters in their hand with your finger. [17]
- 2.6 Do not assume that the person cannot see you. [17]
- 2.7 Avoid the term "over there"; describe positions such as, "to your right / left / straight ahead / behind you" If the person has a service animal on duty, ask them where you should walk to avoid distracting the animal. Do not separate the service animal from its owner. [17]

3. Hearing Impairments

- 3.1 Some persons with hearing impairments may not perceive audio emergency alarms and will need to be alerted to the situation by gestures or by turning the light switch off and on. Do not use the light switch technique if you smell natural gas in the area. Emergency instructions can be given by verbalizing, mouthing, or by a short, explicit note. Example: Fire alarm go out south doors now! [19]
- 3.2 Get the person's attention via a visual cue or a gentle touch on their arm. Do not approach the person from behind. [17]
- 3.3 Face the person, make eye contact when speaking to them as they may rely on lip reading and communicate in close proximity. Speak clearly and naturally. Do not shout or speak unnaturally slowly. [17]
- 3.4 Use gestures to help illustrate your meaning. [17]

- 3.5 If there is time, it may be helpful to write a message. [17]
- 3.6 Hearing aids amplify sounds and can create a physical shock to the user, so do not make loud noises. [17]
- 3.7 Note that some people may be deaf-blind. [17]
- 3.8 Give visual instructions to advise about the safest route or direction by pointing toward exits or evacuation maps. [20]

4. Mobility Impairments/Wheelchair users

- 4.1 Mobility limitations may make it difficult for a person to use stairs or to move quickly over long distances. Limitations may include reliance on mobility equipment such as a wheelchair, walker, crutches or a walking cane. People with a heart condition or respiratory difficulties may also have limited mobility. [17]
- 4.2 Since elevators should not be used for evacuation during a fire alarm, persons with mobility impairments may need assistance in evacuating unless they are on the ground floor with accessible exits. As persons with mobility impairments have varying degrees of limitations, information is offered for two possible scenarios: ambulatory and non-ambulatory impairments. [19]
- 4.3 Try to ensure that the person's wheelchair is transported with the person. [17]
- 4.4 If this is not possible, employ other evacuation techniques as appropriate, such as use of the evacuation chair, shelter-in-place (if instructed to do so), or lifts and carries by trained personnel. [17]
- 4.5 Do not push or pull a person's wheelchair without their permission, unless it is a matter of life or death. [17]
- 4.6 Avoid leaning on wheelchair or assistive device as it is a part of the individual's body space. [18]
- 4.7 Stairway evacuation of wheelchair users should be conducted by trained professionals. Only in situations of extreme danger should untrained people attempt to evacuate wheelchair users. Moving a wheelchair down stairs is never safe. [16]

5. Ambulatory Mobility Impairments

- 5.1 Persons with mobility impairments who are able to walk independently, either with or without the use of crutches or a cane, may be able to negotiate stairs with minor assistance in an emergency. Even some persons who customarily use a wheelchair or scooter for long distance travel may be able to walk independently in an emergency. [19]
- 5.2 If individuals are able to walk up or down stairs, it is advisable that they wait until the heavy traffic has cleared before attempting to evacuate. Someone should walk beside the person to provide assistance in exiting the building, if needed. [19]

6. Speech Disabilities

- 6.1 Identify yourself and offer assistance. [18]
- 6.2 Concentrate on what the person is saying. [18]
- 6.3 Try to ask questions that require only short answers. [18]
- 6.4 Do not speak for the individual or attempt to finish his or her sentences. [18]
- 6.5 If you do not understand something the individual says, do not pretend you do. Ask the person to repeat what he or she said and then repeat it back to confirm. [18]
- 6.6 Be patient. Take as much time as necessary as long as it does not endanger you. [18]
- 6.7 If you are having difficulty understanding the person, ask the individual if it is acceptable to use pen and paper, a talk board, etc. [18]

7. Service Animals:

- 7.1 Guide dogs come in all sizes and breeds from Chihuahuas to Great Danes. If an individual tells you their animal is a service animal, believe them and help them accordingly. [18]
- 7.2 The animal may become scared and disoriented because of the disaster and may not be behaving as usual. Ask the owner to assist in calming the animal and help in its evacuation. [18]
- 7.3 Evacuate the service animal with the individual whenever possible. [18]

References

- [1] Department of Economic and Social Affairs, "Convention on the Rights of Persons with Disabilities (CRPD)," United Nations, [Online]. Available: <https://www.un.org/development/desa/disabilities/convention-on-the-rights-of-persons-with-disabilities.html>. [Accessed January 2021].
- [2] Department of Empowerment of Persons with Disabilities (Divyangjan), "The Rights of Persons with Disabilities (RPwD) Act, 2016," Ministry of Social Justice & Empowerment, Government of India, 14 07 2021. [Online]. Available: <http://disabilityaffairs.gov.in/content/page/acts.php>. [Accessed 26 07 2021].
- [3] Ministry of Law and Justice, *The Rights of Persons with Disabilities Act, 2016*, New Delhi: The Gazette of India, 2016.
- [4] Director General of Civil Aviation, "Civil Aviation Requirements, Section 3 - Air Transport, Series 'M' Part I," Office of the Director General of Civil Aviation, New Delhi, 2014, Revised on 9 July 2021.
- [5] IATA, "Resolution 700: Acceptance and Carriage of Incapacitated Passengers," IATA, 2002.
- [6] Ministry of Urban Development, "Harmonised Guidelines & Standards for Universal Accessibility in India," New Delhi, 2021.
- [7] Central Public Works Department, Chief Architect, "Handbook on Barrier Free and Accessibility," Directorate General, Central Public Works Department, New Delhi, 2014.
- [8] Ministry of Civil Aviation, "Report of the Asok Kumar Committee for the Review of the Civil Aviation Requirements (CAR) for Persons with Disabilities," New Delhi, 2012.
- [9] Ministry of Social Justice and Empowerment, *Accessible India Campaign, Hon'ble MSJE's Review Meeting with Nodal Ministers*, 2019.
- [10] Bureau of Indian Standards, "National Building Code of India," New Delhi, 2016.
- [11] Dr. Gaurav Raheja, "Access Audit Report for Terminal 1-D, Terminal 1-C, Terminal 3, Indira Gandhi International Airport, New Delhi," Indian Institute of Technology, Roorkee, 2016.
- [12] Laurel Van Horn, "Service Animal Relief Areas: Guidance and Best Practice," in *7th Annual FAA National Civil Rights Training Conference for Airports, 9/7-9/2016*, 2016.
- [13] Tata Elxsi Limited, "Wayfinding Manual: Design for way finding in airports," Tata Elxsi Limited, New Delhi, 2021.
- [14] Ministry of Civil Aviation, *Review of Accessible India Campaign - Issuing of Minutes of the meeting regarding*, New Delhi, 2018.
- [15] Bureau of Civil Aviation Security, "AVSEC Circular No. - 01/2022, Standard Operating Procedure for screening of persons with special needs - Individual with disabilities and/or Individual with reduced mobility," Ministry of Civil Aviation, Government of India, New Delhi, 2022.

- [16] Loyola University Maryland, "Evacuation for Persons with Disabilities," [Online]. Available: <https://www.loyola.edu/departments/emergency-preparedness/persons-with-disabilities#guidelines>. [Accessed 26 08 2021].
- [17] P. S. Canada, "Emergency Preparedness Guide for People with Disabilities/Special Needs," Public Safety Canada, 27 02 2018. [Online]. Available: <https://www.getprepared.gc.ca/cnt/rsrscs/pblctns/pplwthdsblts/index-en.aspx>. [Accessed 06 08 2021].
- [18] Accessibility Resource Center for Students, "Emergency Procedures, Evacuation Procedures for Persons with Disabilities," Mt. San Antonio College, [Online]. Available: <https://www.mtsac.edu/access/resources/procedures.html>. [Accessed 06 08 2021].
- [19] Case Western reserve University, "Emergency Evacuation for Persons with Disabilities," 2021. [Online]. Available: <https://case.edu/studentlife/disability/policies-and-procedures/emergency-evacuation-persons-disabilities#:~:text=In%20the%20event%20of%20an,or%20her%20of%20any%20obstacles..> [Accessed 06 08 2021].
- [20] UC Santa Cruz, "Emergency Procedures for Persons with a Disability," Office of Emergency Services, 04 06 2020. [Online]. Available: <https://oes.ucsc.edu/emergency-preparedness/procedures/ada-evacuation.html>. [Accessed 06 08 2021].
- [21] United Nations, "Accessibility for the Disabled - A Design Manual for a Barrier Free Environment," Department of Economic and Social Affairs, 2003-04. [Online]. Available: <https://www.un.org/esa/socdev/enable/designm/AD1-07.htm>. [Accessed 19 August 2020].
- [22] Diversity and Equal Opportunity Centre (DEOC), "Comparison of different guidelines for the accessibility of built environment in India - A Brief Analysis and Recommendations," National Centre for Promotion of Employment for Disabled People (NCPEDP), 2016.
- [23] Bureau of Civil Aviation Security, *Addendum to Circular No. 4/2014, Standard Operating Procedure for Screening of Passengers with Special Needs and Medical conditions*, New Delhi: Ministry of Civil Aviation, Government of India, 2017.
- [24] Bureau of Civil Aviation, *AVSEC Circular No. - 04/2014, Standard operating procedure for screening of passengers with special needs and medical conditions*, New Delhi: Ministry of Civil Aviation, Government of India, 2014.
- [25] National Academies of Sciences, Engineering, and Medicine, "Airport Emergency Communications for People with Disabilities and Others with Access and Functional Needs," The National Academies Press, Washington, DC, 2019.
- [26] MoHUA; IITR; NIUA; Basic; UK Government, "Key Findings: Public Consultation on Guidelines & Standards for Universal Accessibility in India," National Institute of Urban Affairs, New Delhi, 2021.

Annexure A

1. Support for Persons with Intellectual Disabilities (PwIDs)

- 1.1 Many of PwIDs need to travel with a Care-giver. The duo needs to be together all the time; during checking in process, during security check-in, during emplaning/deplaning, in many cases during visits to wash-room, during availing terminal bus services etc.
- 1.2 Service providers, Security staff, Cabin crew should be aware/ sensitized about high support and special needs of PwIDs, to be able to allay fears of PwID during above mentioned processes.
- 1.3 Some of the earmarked seats for Persons with Disabilities in waiting areas should be located in secluded, low noise and preferably with lower lighting areas. The seats should be in pair to accommodate care giver.
- 1.4 In waiting areas/ queues the PwIDs and their care giver should be given priority and their disability should not be misinterpreted with wheelchair sign, as these persons may not have outward signs of physical or sensory impairment. It is recommended that customers share their requirements at the time of booking. It is also recommended that customers requiring continuous care shall travel with a safety assistant or care giver.
- 1.5 Announcements in PA systems and approach towards PwIDs and towards their care giver should be in normal tone and not in excited or annoying tone, to avoid triggering panic and atypical behavior in PwIDs.
- 1.6 There have been instances where co-passengers, due to their hyper insensitivity, have asked PwIDs to be removed. The Commander & Cabin crews should be made aware about such instances (as case studies) and the Rights of Persons with Disability Act; to be able to intervene in a positive manner during such situations. Only when the aircraft cannot safely depart due to the inability of the safety assistant to assist/manage the PWID is when the customer may be accommodated in another flight.
- 1.7 If requested by Care-giver, a special announcement should be made regarding special needs or situational behavior of PwID passenger to avoid PwID subjected to undue attention or maltreatment. However, announcement should be made if absolutely necessary as it could bring in undue attention towards the passenger as well.
- 1.8 During ticketing, preference to avail adjacent seating for PwID and care giver should be given on priority and at no extra. The customers are recommended to prebook their seats on Airline websites.
- 1.9 Wherever for any reason (such as security check, immigration check etc.) if the PwID and his/ her care-giver need to be separated for some time, the facility in-charge (terminal operator/ security agency/ airlines/ immigration authority, custom authority etc) should be made statutorily responsible to provide escort for the PwID in order that he/ she is not lost or land-up in abnormal situation.

RECEPTION DESK



LIGHT WOOD VENEER

COLOR : ALMOND CHERRY
 BASE MATERIAL : MDF
 THICKNESS : 3 MM.
 PANEL SURFACE : POLISHED



LIGHT WOOD VENEER

COLOR : LIGHT BEIGE
 BASE MATERIAL : MDF
 THICKNESS : 3 MM.
 PANEL SURFACE : POLISHED



ACRYLIC SHEET

COLOR : PURE WHITE
 BASE MATERIAL : ACRYLIC
 THICKNESS : 3 - 12 MM.
 PANEL SURFACE : GLOSSY

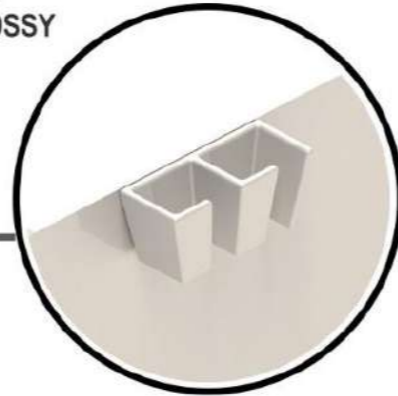

ATTACHED GROOVE

TO ACCOMODATE SUPPORT
 STICK USED BY HANDICAPPED
 PEOPLE OR SENIOR CITIZENS

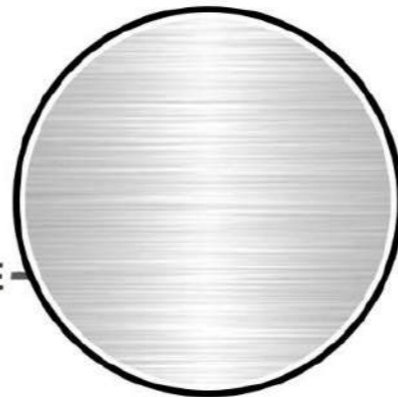

AIRPORT SIGNAGE

COLOR : WHITE
 BASE MATERIAL : METAL
 THICKNESS : 3 - 5 MM.
 PANEL SURFACE : FINISHED

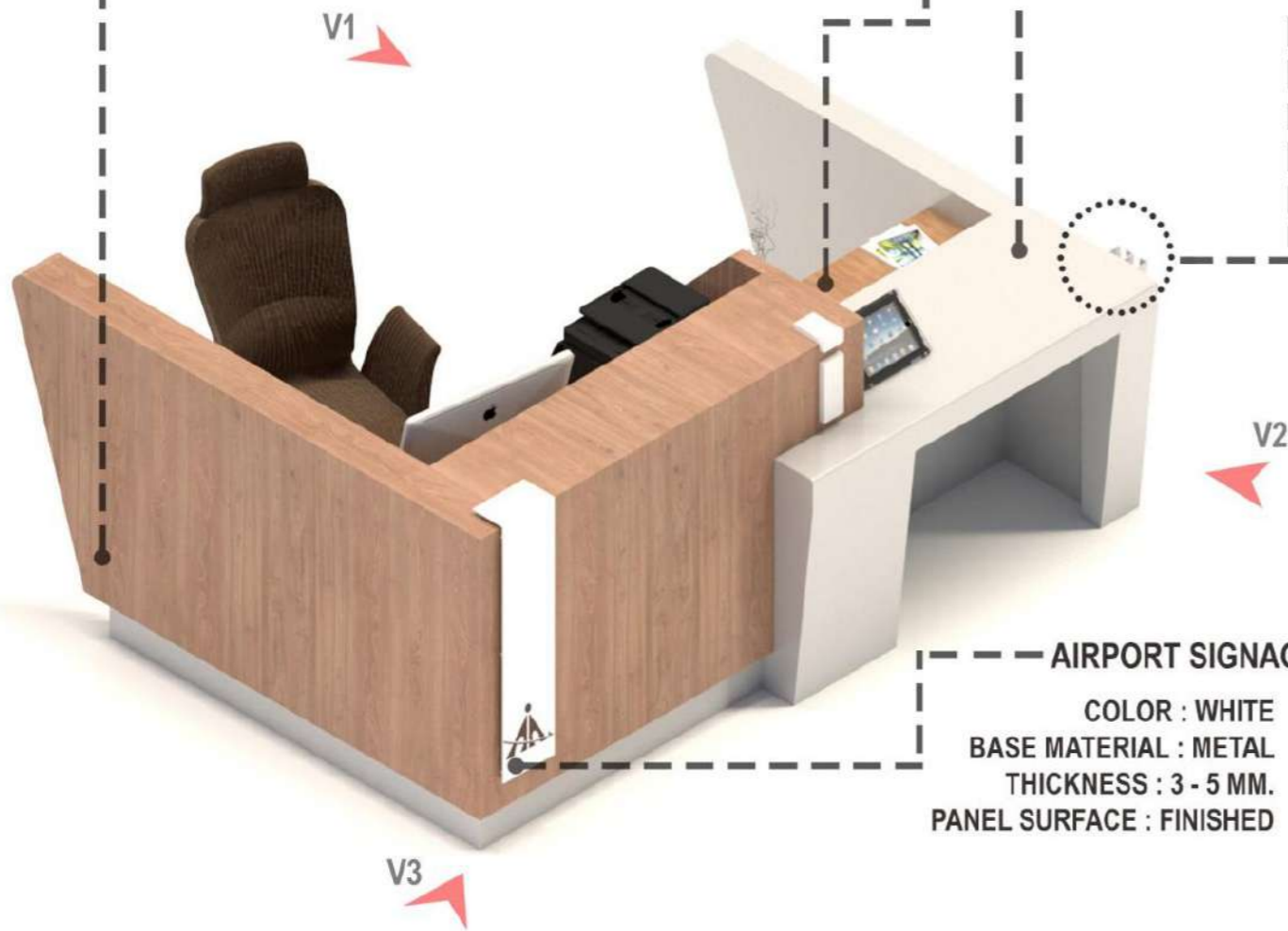

VIEW 1



VIEW 2



VIEW 3





SECTION XX'

SECTION YY'

FFL

SECTIONS

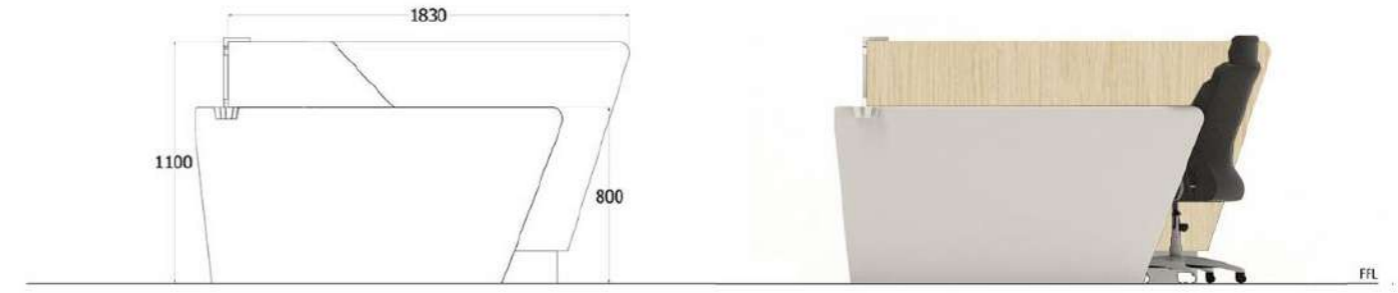

FFL

RIGHT SIDE ELEVATION

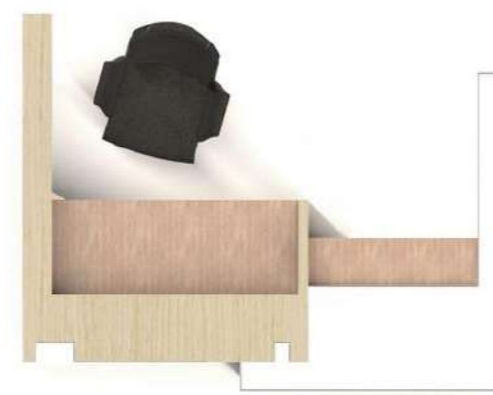
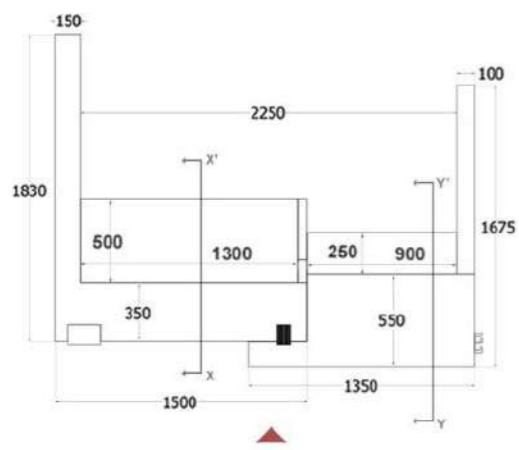

PLAN

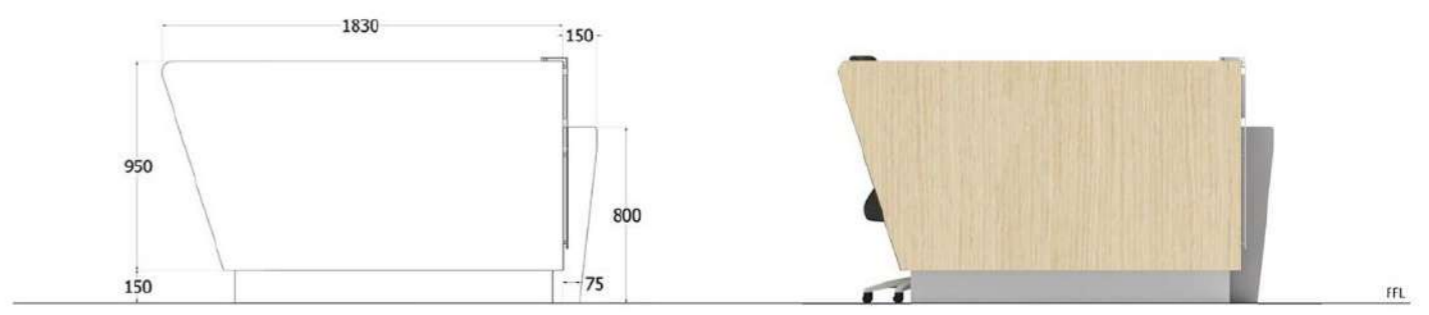

FFL

LEFT SIDE ELEVATION

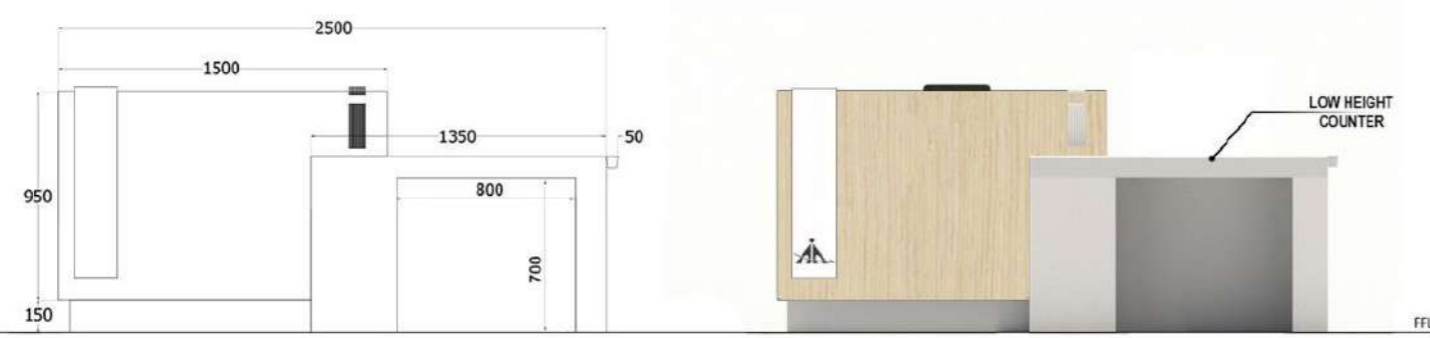

FFL

FRONT ELEVATION

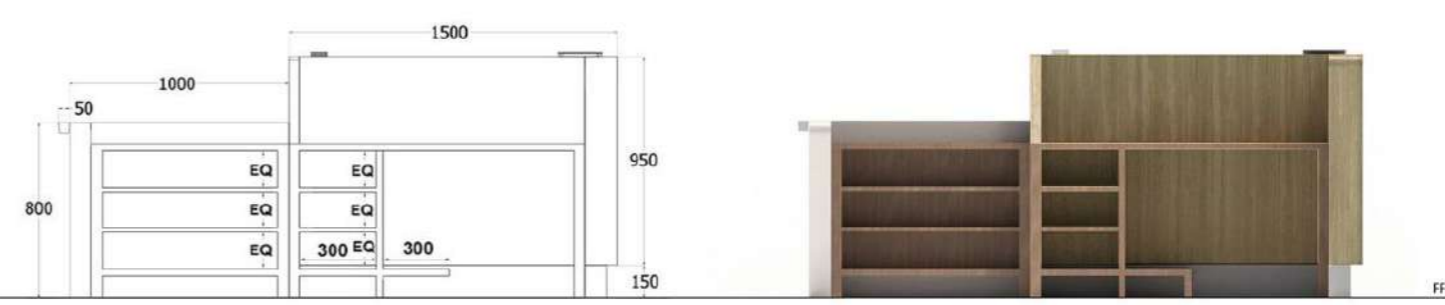

FFL

BACK ELEVATION

* all dimensions are in mm *



